

CE EMC Test Report

(EN 50155 & EN 50121-3-2)

Report No.: CE190124C20 R1

Test Model: ECX-1200 / ECX-1400

Series Model: ECX-1XXXXXXXXXXXXXXXXXXXX ("X" can be 0-9, A-Z or blank for marketing purpose)

Received Date: Jan. 24, 2019

Test Date: Feb. 13, 2019 ~ Apr. 12, 2019

Issued Date: Apr. 16, 2019

Applicant: VECOW CO., LTD.

Address: 12F., No.111, Zhongcheng Rd., Tucheng Dist., New Taipei City 23674, Taiwan (R.O.C.)

Issued By: Bureau Veritas Consumer Products Services (H.K.) Ltd., Taoyuan Branch

Lab Address: No. 47-2, 14th Ling, Chia Pau Vil., Lin Kou Dist., New Taipei City, Taiwan (R.O.C.)

Test Location: No.19, Hwa Ya 2nd Rd., Wen Hwa Vil., Kwei Shan Dist., Taoyuan City 33383, TAIWAN (R.O.C.)



This report is for your exclusive use. Any copying or replication of this report to or for any other person or entity, or use of our name or trademark, is permitted only with our prior written permission. This report sets forth our findings solely with respect to the test samples identified herein. The results set forth in this report are not indicative or representative of the quality or characteristics of the lot from which a test sample was taken or any similar or identical product unless specifically and expressly noted. Our report includes all of the tests requested by you and the results thereof based upon the information that you provided to us. You have 60 days from date of issuance of this report to notify us of any material error or omission caused by our negligence, provided, however, that such notice shall be in writing and shall specifically address the issue you wish to raise. A failure to raise such issue within the prescribed time shall constitute your unqualified acceptance of the completeness of this report, the tests conducted and the correctness of the report contents. Unless specific mention, the uncertainty of measurement has been explicitly taken into account to declare the compliance or non-compliance to the specification. The report must not be used by the client to claim product certification, approval, or endorsement by A2LA or any agency of the federal government. The report must not be used by the client to claim product certification, approval, or endorsement by TAF or any government agencies.

Table of Contents

Release Control Record	4
1 Certificate of Conformity	5
2 Summary of Test Results	6
2.1 Specific Immunity Requirements by Manufacturer	8
2.2 Performance Criteria	8
2.3 Measurement Uncertainty	8
2.4 Modification Record.....	8
3 General Information	9
3.1 Description of EUT	9
3.2 Operating Modes of EUT and Determination of Worst Case Operating Mode	10
3.3 Test Program Used and Operation Descriptions.....	12
3.4 Primary Clock Frequencies of Internal Source.....	12
3.5 Miscellaneous.....	13
4 Configuration and Connections with EUT.....	14
4.1 Connection Diagram of EUT and Peripheral Devices	14
4.2 Configuration of Peripheral Devices and Cable Connections	19
5 Conducted Disturbance at Auxiliary a.c. or d.c. Power Ports	21
5.1 Limits	21
5.2 Test Instruments	21
5.3 Test Arrangement	22
5.4 Test Results	23
6 Radiated Disturbance up to 1 GHz	25
6.1 Limits	25
6.2 Test Instruments	25
6.3 Test Arrangement	26
6.4 Test Results	27
7 Radiated Disturbance above 1 GHz	29
7.1 Limits	29
7.2 Test Instruments	30
7.3 Test Arrangement	31
7.4 Test Results	32
8 Electrostatic Discharge Immunity Test (ESD).....	34
8.1 Test Specification	34
8.2 Test Instruments	34
8.3 Test Arrangement	35
8.4 Test Results	36
9 Radio-frequency Electromagnetic Field Immunity Test (RS)	51
9.1 Test Specification	51
9.2 Test Instruments	51
9.3 Test Arrangement	52
9.4 Test Results	53
10 Electrical Fast Transient/Burst Immunity Test (EFT).....	54
10.1 Test Specification	54
10.2 Test Instruments	54
10.3 Test Arrangement	54
10.4 Test Results	55

11	Surge Immunity Test.....	56
11.1	Test Specification	56
11.2	Test Instruments	56
11.3	Test Arrangement	56
11.4	Test Results	57
12	Immunity to Conducted Disturbances Induced by RF Fields (CS).....	58
12.1	Test Specification	58
12.2	Test Instruments	58
12.3	Test Arrangement	59
12.4	Test Results	60
13	Pictures of Test Arrangements	61
13.1	Conducted Disturbance at Auxiliary a.c. or d.c. power ports	61
13.2	Radiated Disturbance up to 1 GHz	62
13.3	Electrostatic Discharge Immunity Test (ESD)	63
13.4	Radio-frequency Electromagnetic Field Immunity Test (RS)	66
13.5	Fast Transients (EFT).....	69
13.6	Surge	72
13.7	Radio-frequency common mode (CS).....	74
	Appendix – Information of the Testing Laboratories	78

Release Control Record

Issue No.	Description	Date Issued
CE190124C20	Original Release	Mar. 29, 2019
CE190124C20 R1	Added EN 50155	Apr. 16, 2019

1 Certificate of Conformity

Product: Expandable Fanless System
Brand: Vecow
Test Model: ECX-1200 / ECX-1400
Series Model: ECX-1XXXXXXXXXXXXXXXXXXXX ("X" can be 0-9, A-Z or blank for marketing purpose)
Sample Status: MASS-PRODUCTION
Applicant: VECOW CO., LTD.
Test Date: Feb. 13, 2019 ~ Apr. 12, 2019
Standards: **EN 50155:2007 +AC:2010 +AC:2012, Clause 12.2.7 & 12.2.8**
EN 50121-1:2017
EN 50121-3-2:2016
EN 61000-4-2:2009
EN 61000-4-3:2006 +A1:2008 +A2:2010
EN 61000-4-4:2012
EN 61000-4-5:2014
EN 61000-4-6:2014

The above equipment has been tested by **Bureau Veritas Consumer Products Services (H.K.) Ltd., Taoyuan Branch**, and found compliance with the requirement of the above standards. The test record, data evaluation & Equipment Under Test (EUT) configurations represented herein are true and accurate accounts of the measurements of the sample's EMC characteristics under the conditions specified in this report.

Prepared by : Gina Liu , **Date:** Apr. 16, 2019
Gina Liu / Specialist

Approved by : Carl Chen , **Date:** Apr. 16, 2019
Carl Chen / Project Engineer

2 Summary of Test Results

EN 50121-3-2:2016, Emission EN 50155:2007 +AC:2010 +AC:2012, Clause 12.2.8.2			
Port	Test Item / specifications	Result/Remarks	Verdict
Auxiliary a.c. or d.c. power ports - Auxiliary supply sinusoidal a.c. or d.c.	Conducted disturbance 150 kHz- 500 kHz: 99 dB μ V quasi-peak 500 kHz- 30 MHz: 93 dB μ V quasi-peak	Minimum passing margin is -27.20 dB at 18.07400 MHz	Pass
Auxiliary a.c. or d.c. power ports – AC power outlet port for public use	Conducted disturbance 50 Hz- 2 kHz: THD <8% (THD: total harmonic distortion)	Test not applicable because the port does not exist.	N/A
Battery referenced ports - Battery power supply	Conducted disturbance 150 kHz- 500 kHz: 99 dB μ V quasi-peak 500 kHz- 30 MHz: 93 dB μ V quasi-peak	Test not applicable because the port does not exist.	N/A
Enclosure	Radiated disturbance 30 MHz- 230 MHz: 40 dB μ V/m quasi-peak 230 MHz -1 GHz: 47 dB μ V/m quasi-peak	Minimum passing margin is -3.12 dB at 375.00 MHz	Pass
Enclosure	Radiated disturbance 1 GHz- 3 GHz: 76 dB μ V/m peak 56 dB μ V/m average 3 GHz - 6 GHz: 80 dB μ V/m peak 60 dB μ V/m average	Minimum passing margin is -6.39 dB at 2415.03 MHz	Pass

EN 50121-3-2:2016, Immunity requirements, EN 50155:2007 +AC:2010 +AC:2012, Clause 12.2.7 & 12.2.8.1					
Table Clause	Basic standard	Port	Test Item / specifications	Result/Remarks	Verdict
3.1	EN 61000-4-6:2014	Battery referenced ports (except at the output of energy sources), Auxiliary a.c. power input ports (rated voltage \leq 400 Vrms)	Radio-frequency common mode (CS) 80% AM (1kHz) 0.15-80 MHz, 10V Performance Criterion A	Performance Criterion A	Pass
3.2	EN 61000-4-4:2012	Battery referenced ports (except at the output of energy sources), Auxiliary a.c. power input ports (rated voltage \leq 400 Vrms)	Fast Transients (EFT) 5/50 (T _r /T _h) ns, 5kHz \pm 2kV Performance Criterion A	Performance Criterion A	Pass
3.3	EN 61000-4-5:2014	Battery referenced ports (except at the output of energy sources), Auxiliary a.c. power input ports (rated voltage \leq 400 Vrms)	Surges 1.2/50 (8/20) (T _r /T _h) μ s Line to ground: \pm 2kV 42 Ω , 0.5 μ F Line to line: \pm 1kV 42 Ω , 0.5 μ F Performance Criterion B	Performance Criterion A	Pass

EN 50121-3-2:2016, Immunity requirements,
EN 50155:2007 +AC:2010 +AC:2012, Clause 12.2.7 & 12.2.8.1

Table Clause	Basic standard	Port	Test Item / specifications	Result/Remarks	Verdict
4.1	EN 61000-4-6:2014	Signal & communication, process measurement & control ports	Radio-frequency common mode (CS) 80 AM (1kHz) 0.15-80 MHz, 10V	Performance Criterion A	Pass
4.2	EN 61000-4-4:2012	Signal & communication, process measurement & control ports	Fast Transients (EFT) 5/50 (T _r /T _n) ns, 5kHz ±2kV, Capacitive clamp Performance Criterion A	Performance Criterion A	Pass
5.1	EN 61000-4-3:2006 +A1:2008 +A2:2010	Enclosure ports	Radio-frequency electromagnetic field amplitude modulated (RS) ¹ , 80% AM (1kHz) 80-800 MHz, 20V/m Performance Criterion A	Performance Criterion A	Pass
5.2	EN 61000-4-3:2006 +A1:2008 +A2:2010	Enclosure ports	Radio-frequency electromagnetic field from digital mobile telephones (RS) ² , 80% AM (1kHz) 800-1000 MHz, 20V/m 1400-2000 MHz, 10V/m 2000-2700 MHz, 5V/m 5100-600 MHz, 3V/m Performance Criterion A	Performance Criterion A	Pass
5.3	EN 61000-4-2:2009	Enclosure ports	Electrostatic Discharges (ESD) ±6kV Contact discharge ±8kV Air discharge Performance Criterion B	Performance Criterion A	Pass

Note 1: This limit applies to equipment mounted in the passenger compartments, drivers cab or external to the rolling stock (roof, underframe). For equipment mounted in all other areas a severity level of 10 V/m may be used.

Note 2: For large apparatus (e.g. traction drives, auxiliary converters) it is often not practical to perform the immunity test to radiated electromagnetic fields on the complete unit. In such cases the manufacturer should test susceptible sub-systems (e.g. control electronics). The test report should justify the selection or not of sub-systems and any assumptions made (e.g. reduction of field due to case shielding).

N/A: Not Applicable

Note:

1. There is no deviation to the applied test methods and requirements covered by the scope of this report.
2. Determining compliance based on the results of the compliance measurement, not taking into account measurement instrumentation uncertainty.

2.1 Specific Immunity Requirements by Manufacturer

2.2 Performance Criteria

General Performance Criteria

The general performance criteria apply for those ports for which no specific performance criteria are defined (e.g. auxiliary ports) in the report.

Performance criterion A: The apparatus shall continue to operate as intended during and after the test. No degradation of performance or loss of function is allowed below a performance level specified by the manufacturer, when the apparatus is used as intended. The performance level may be replaced by a permissible loss of performance. If the minimum performance level or the permissible performance loss is not specified by the manufacturer, either of these may be derived from the product description and documentation, and from what the user may reasonably expect from the apparatus if used as intended..

Performance criterion B: The apparatus shall continue to operate as intended after the test. No degradation of performance or loss of function is allowed below a performance level specified by the manufacturer, when the apparatus is used as intended. The performance level may be replaced by a permissible loss of performance. During the test, degradation of performance is however allowed. No change of actual operating state or stored data is allowed. If the minimum performance level or the permissible performance loss is not specified by the manufacturer, either of these may be derived from the product description and documentation, and from what the user may reasonably expect from the apparatus if used as intended.

Performance criterion C: Temporary loss of function is allowed, provided the function is selfrecoverable or can be restored by the operation of the controls.

2.3 Measurement Uncertainty

Where relevant, the following measurement uncertainty levels have been estimated for tests performed on the EUT as specified in CISPR 16-4-2:

Measurement	Expanded Uncertainty (k=2) (\pm)	Maximum allowable uncertainty (\pm)
Conducted disturbance at mains port using AMN, 150kHz ~ 30MHz	2.44 dB	3.4 dB (U_{cispr})
Radiated disturbance, 30MHz ~ 1GHz	4.29 dB	6.3 dB (U_{cispr})
Radiated disturbance, 1GHz ~ 6GHz	2.26 dB	5.2 dB (U_{cispr})

The other instruments specified are routine verified to remain within the calibrated levels, no measurement uncertainty is required to be calculated.

2.4 Modification Record

There were no modifications required for compliance.

3 General Information

3.1 Description of EUT

Product	Expandable Fanless System
Brand	Vecow
Test Model	ECX-1200 / ECX-1400
Series Model	ECX-1XXXXXXXXXXXXXXXXXXXX ("X" can be 0-9, A-Z or blank for marketing purpose)
Sample Status	MASS-PRODUCTION
Operating Software	Windows 10
Power Supply Rating	24 Vdc (Adapter)
Accessory Device	Refer to Note as below
Data Cable Supplied	Refer to Note as below

Note:

1. All models are listed as below.

Brand	Model	Difference
Vecow	ECX-1200	The ECX-1200 and ECX-1400 are with different appearance and quantity of slot but same for the electrical and layout.
	ECX-1400	

2. The EUT contains following accessory devices.

Product	Brand	Model	Description
Adapter	Meanwell	GST160A24-R7B	I/P: 100-240 Vac, 50/60 Hz, 2.0 A O/P: 24 Vdc, 6.67 A 1.2m non-shielded cable with 1 core
CPU	Intel	I7-8700	3.2GHz
RAM	Kingston	KVR21S15S8/4	4GB

3. There're 2 configurations for the EUT listed as below.

Sample A: ECX-1400

Sample B: ECX-1200

3.2 Operating Modes of EUT and Determination of Worst Case Operating Mode

Test modes are presented in the report as below.

Mode	Config.	Test Condition
Conducted Emission		
1	A	LAN Link + POE LAN with Camera*4 + USB with M/S + USB with K/B + USB with Flash*3 + RS232 Loop + Mic&Earphone + DP with Monitor*2 + VGA with Monitor + DVI-D Cable + DIO 1&2 Cable + Adapter + CF Card + USB Link Printer
2	A	LAN Link + POE LAN with Camera*4 + USB with M/S + USB with K/B + USB with Flash*3 + RS232 Loop + Mic&Earphone + DP with Monitor*2 + VGA Cable + DVI-D with Monitor + DIO 1&2 Cable + Adapter + CF Card + USB Link Printer
3	B	LAN Link + POE LAN with Camera*4 + USB with M/S + USB with K/B + USB with Flash*3 + RS232 Loop + Mic&Earphone + DP with Monitor*2 + VGA with Monitor + DVI-D Cable + DIO 1&2 Cable + Adapter + CF Card + USB Link Printer
Radiated Emission		
1	A	LAN Link + POE LAN with Camera*4 + USB with M/S + USB with K/B + USB with Flash*3 + RS232 Loop + Mic&Earphone + DP with Monitor*2 + VGA with Monitor + DVI-D Cable + DIO 1&2 Cable + Adapter + CF Card + USB Link Printer
2	A	LAN Link + POE LAN with Camera*4 + USB with M/S + USB with K/B + USB with Flash*3 + RS232 Loop + Mic&Earphone + DP with Monitor*2 + VGA Cable + DVI-D with Monitor + DIO 1&2 Cable + Adapter + CF Card + USB Link Printer
3	B	LAN Link + POE LAN with Camera*4 + USB with M/S + USB with K/B + USB with Flash*3 + RS232 Loop + Mic&Earphone + DP with Monitor*2 + VGA with Monitor + DVI-D Cable + DIO 1&2 Cable + Adapter + CF Card + USB Link Printer

Remark:

1. For conducted emission test, test mode 1 was the worst case and only this mode was presented in the report.
2. For radiated emission test, test mode 1 was the worst case and only this mode was presented in the report.

Mode	Config.	Test Condition
RS, Surge tests		
1	A	LAN Link + POE LAN with Camera*4 + USB with M/S + USB with K/B + USB with Flash*4 + RS232 Loop + Mic&Earphone + DP with Monitor*2 + VGA with Monitor + DVI-D Cable + DIO 1&2 Cable + Adapter + CF Card
2	A	LAN Link + POE LAN with Camera*4 + USB with M/S + USB with K/B + USB with Flash*4 + RS232 Loop + Mic&Earphone + DP with Monitor*2 + VGA Cable + DVI-D with Monitor + DIO 1&2 Cable + Adapter + CF Card
3	B	LAN Link + POE LAN with Camera*4 + USB with M/S + USB with K/B + USB with Flash*4 + RS232 Loop + Mic&Earphone + DP with Monitor*2 + VGA with Monitor + DVI-D Cable + DIO 1&2 Cable + Adapter + CF Card
ESD test		
1	A	LAN Link + POE LAN with Camera*4 + USB with M/S + USB with K/B + USB with HDD*4 + RS232 Loop + Mic&Earphone + DP with Monitor*2 + VGA with Monitor + DVI-D Cable + DIO 1&2 Cable + Adapter + CF Card
2	A	LAN Link + POE LAN with Camera*4 + USB with M/S + USB with K/B + USB with HDD*4 + RS232 Loop + Mic&Earphone + DP with Monitor*2 + VGA Cable + DVI-D with Monitor + DIO 1&2 Cable + Adapter + CF Card
3	B	LAN Link + POE LAN with Camera*4 + USB with M/S + USB with K/B + USB with HDD*4 + RS232 Loop + Mic&Earphone + DP with Monitor*2 + VGA with Monitor + DVI-D Cable + DIO 1&2 Cable + Adapter + CF Card

Mode	Config.	Port	Test Condition
EFT and CS tests			
1	A	-	LAN Link + POE LAN with Camera*4 + USB with M/S + USB with K/B + USB with Flash*4 + RS232 Loop + Mic&Earphone + DP with Monitor*2 + VGA with Monitor + DVI-D Cable + DIO 1&2 Cable + Adapter + CF Card
2	A	-	LAN Link + POE LAN with Camera*4 + USB with M/S + USB with K/B + USB with Flash*4 + RS232 Loop + Mic&Earphone + DP with Monitor*2 + VGA Cable + DVI-D with Monitor + DIO 1&2 Cable + Adapter + CF Card
3	B	-	LAN Link + POE LAN with Camera*4 + USB with M/S + USB with K/B + USB with Flash*4 + RS232 Loop + Mic&Earphone + DP with Monitor*2 + VGA with Monitor + DVI-D Cable + DIO 1&2 Cable + Adapter + CF Card
4	A	LAN1	LAN Link + POE LAN with Camera*4 + USB with M/S + USB with K/B + USB with Flash*4 + RS232 Loop + Mic&Earphone + DP with Monitor*2 + VGA with Monitor + DVI-D Cable + DIO 1&2 Cable + Adapter + CF Card
5	A	POE LAN6	LAN Link + POE LAN with Camera*4 + USB with M/S + USB with K/B + USB with Flash*4 + RS232 Loop + Mic&Earphone + DP with Monitor*2 + VGA with Monitor + DVI-D Cable + DIO 1&2 Cable + Adapter + CF Card
6	B	LAN1	LAN Link + POE LAN with Camera*4 + USB with M/S + USB with K/B + USB with Flash*4 + RS232 Loop + Mic&Earphone + DP with Monitor*2 + VGA with Monitor + DVI-D Cable + DIO 1&2 Cable + Adapter + CF Card
7	B	POE LAN6	LAN Link + POE LAN with Camera*4 + USB with M/S + USB with K/B + USB with Flash*4 + RS232 Loop + Mic&Earphone + DP with Monitor*2 + VGA with Monitor + DVI-D Cable + DIO 1&2 Cable + Adapter + CF Card

3.3 Test Program Used and Operation Descriptions

<Emission Tests>

- a. The EUT was charged from adapter.
- b. The EUT linked with Notebooks via cat5e cables.
- c. The EUT linked with Monitors via DP, DVI and VGA cables.
- d. The EUT read and wrote data with HDDs.
- e. The EUT linked with Printer via USB cable.
- f. The EUT linked with cameras via cat5e cables.
- g. The EUT linked with Terminals, IGN Cables, Ground Cable and DIO Cables.
- h. The EUT communicated data with the Notebooks, which acted as communication partners.

<Immunity Tests>

Test Mode 1, 3, 4, 5

- a. The EUT was charged from adapter.
- b. The EUT linked with Switch Hub via cat5e cables.
- c. The EUT linked with Monitors via VGA and DP cables.
- d. The EUT read and wrote data with HDDs / Flashes.
- e. The EUT linked with cameras via cat5e cables.
- f. The EUT linked with DIO, On/off, GND, DVI cables.
- g. The Switch Hub linked with Notebooks via Cat5e cable
- h. The EUT communicated data with the Notebooks, which acted as communication partners.

Test Mode 2, 6, 7

- a. The EUT was charged from adapter.
- b. The EUT linked with Switch Hub via cat5e cables.
- c. The EUT linked with Monitors via DVI and DP cables.
- d. The EUT read and wrote data with HDDs / Flashes.
- e. The EUT linked with cameras via cat5e cables.
- f. The EUT linked with DIO, On/off, GND, VGA cables.
- g. The Switch Hub linked with Notebooks via Cat5e cable
- h. The EUT communicated data with the Notebooks, which acted as communication partners.

3.4 Primary Clock Frequencies of Internal Source

The highest frequency generated or used within the EUT or on which the EUT operates or tunes is 3.2 GHz, provided by {applicant}, for detailed internal source, please refer to the manufacturer's specifications.

3.5 Miscellaneous

➤ Affix CE marking

The marking must be placed visibly and legibly on the product or, if not possible due to the nature of the product, be affixed to the packaging and the accompanying document. The CE marking shall consist of the initials 'CE' taking the following form:

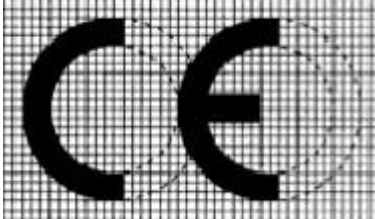

The various components of the CE marking must have the same vertical dimension, and may not be smaller than 5 mm. If the CE marking is reduced or enlarged, the proportions given in the graduated drawing above must be respected.

When the product is subject to other Directives covering other aspects and which also provide for the 'CE' marking, the accompanying documents must indicate that the product also conforms to those other Directives.

However, when one or more of those Directives allow the manufacturer, during a transitional period, to choose which arrangements to apply, the 'CE' marking has to indicate conformity only with the Directives applied by the manufacturer. In this case, the particularities of the Directives applied, as published in the Official Journal of the European Union, must be given in the documents, notices or instructions required by the Directives and accompanying such products.

4 Configuration and Connections with EUT

4.1 Connection Diagram of EUT and Peripheral Devices

Emission tests:

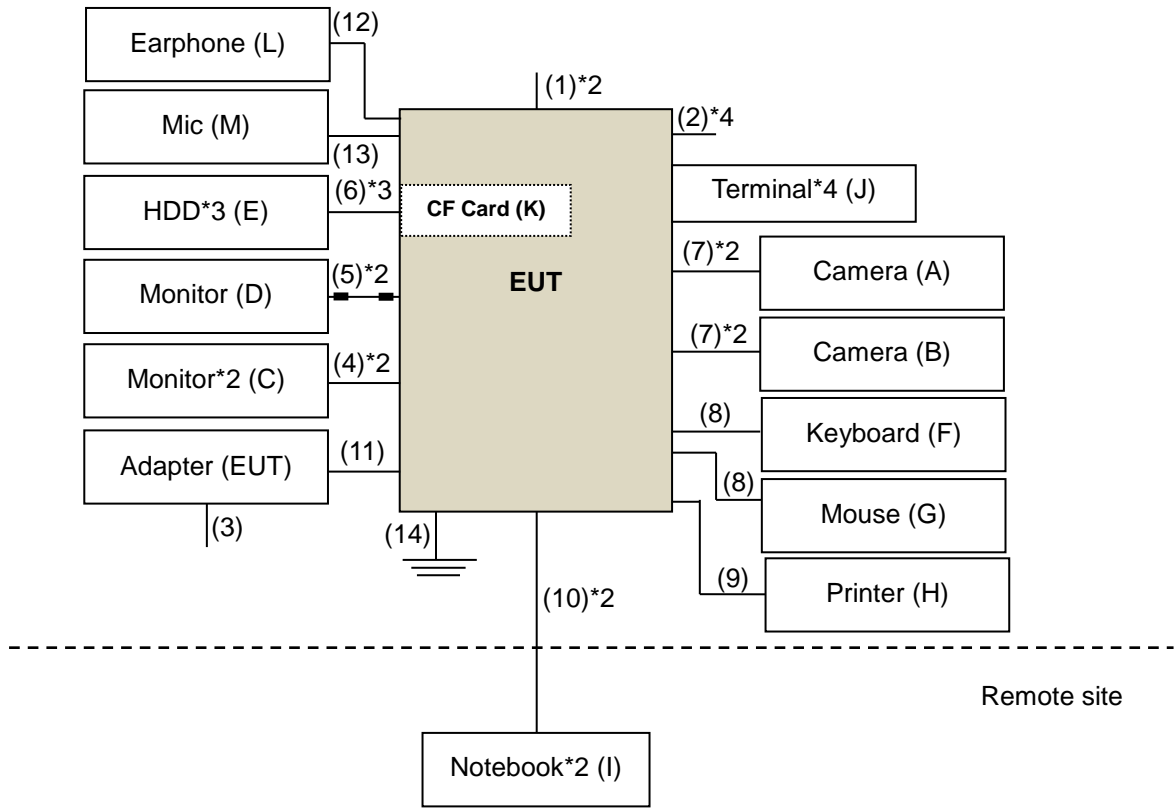

Immunity tests (ESD excluded):
 Test Mode 1, 3, 4, 5

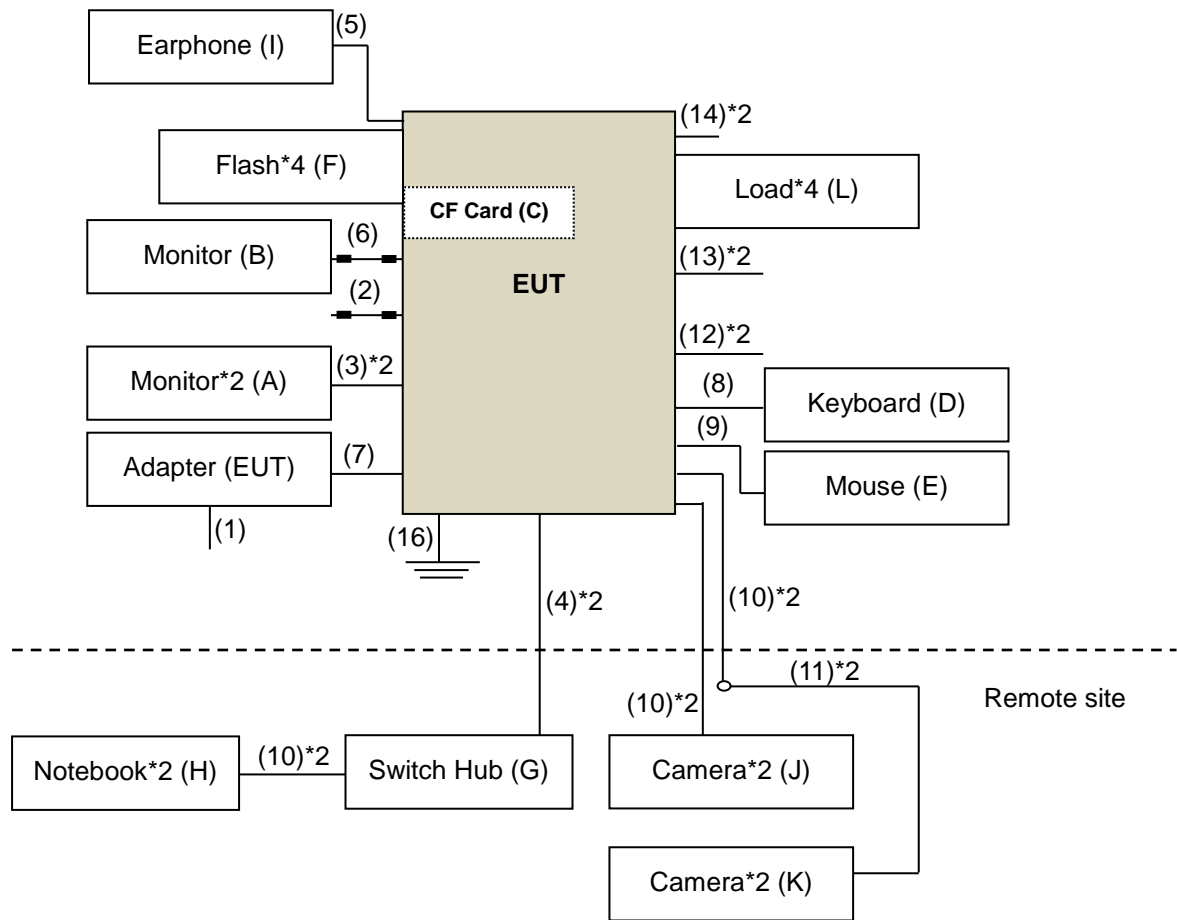

Test Mode 2, 6, 7

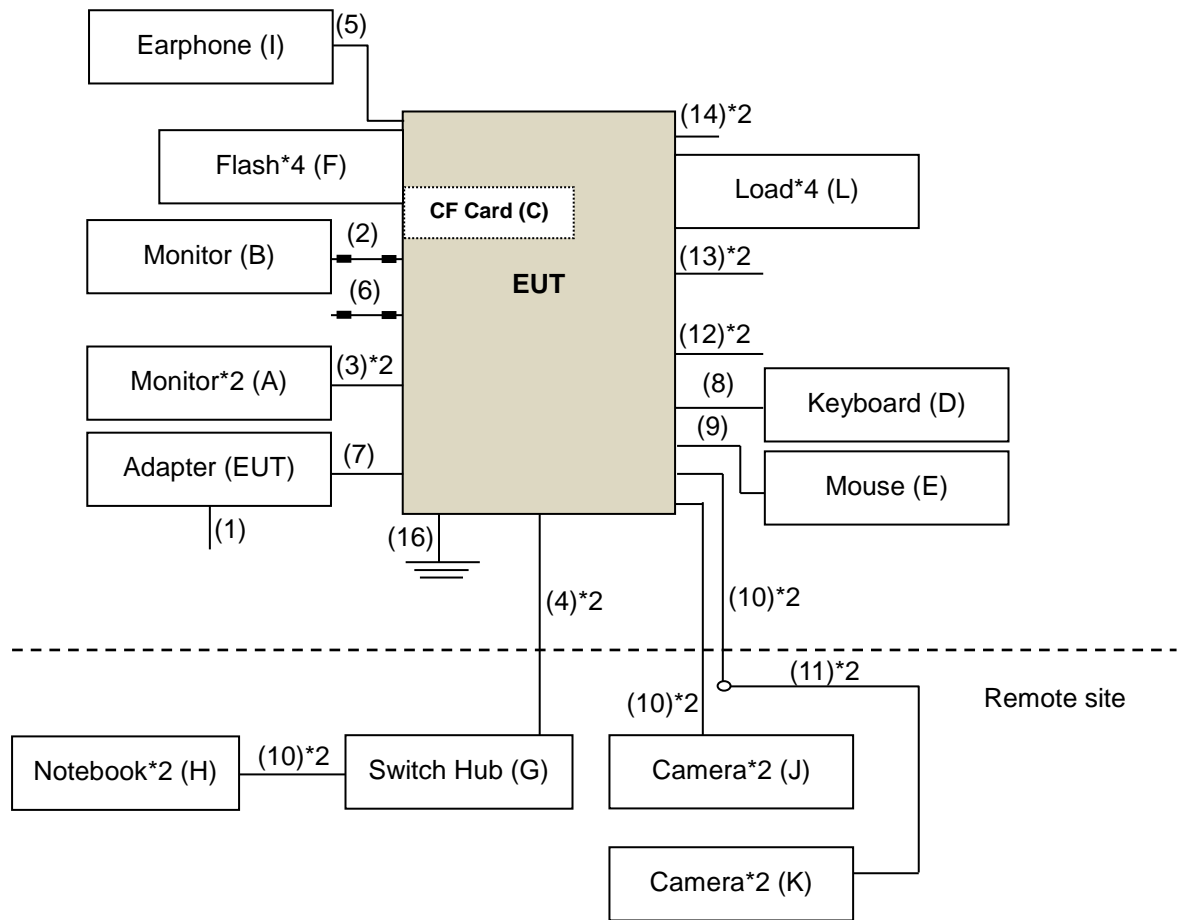

ESD tests:
Test Mode 1, 3

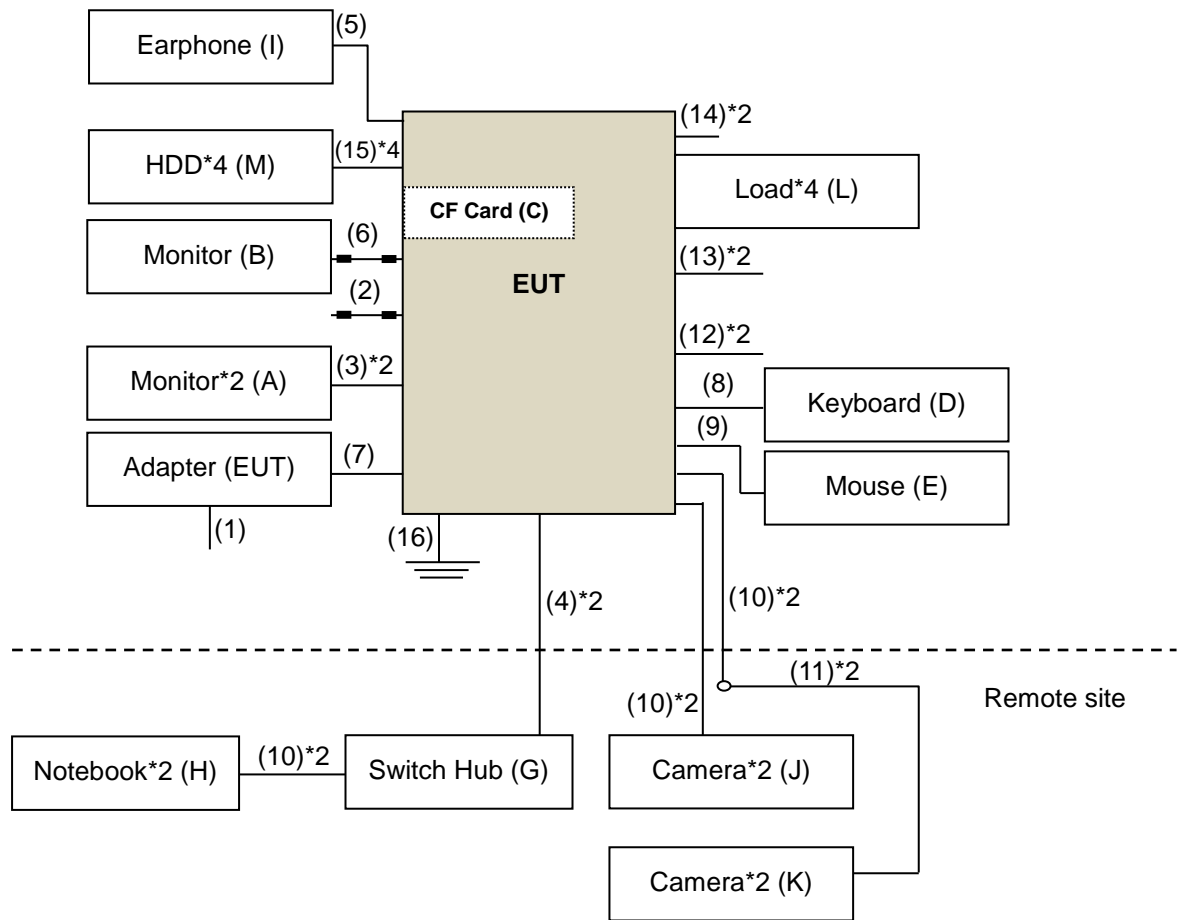

Test Mode 2

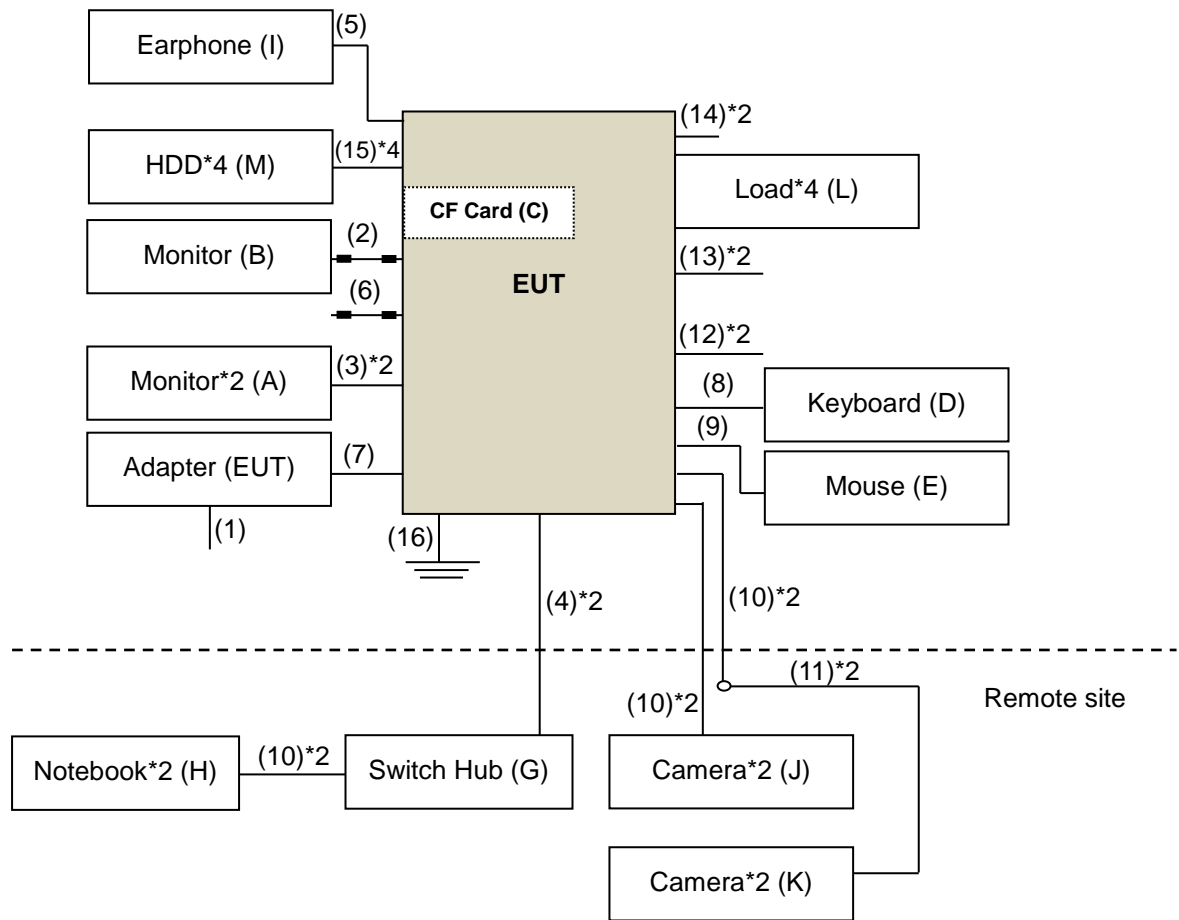

4.2 Configuration of Peripheral Devices and Cable Connections

Emission tests:

ID	Product	Brand	Model No.	Serial No.	FCC ID	Remarks
A.	Camera	3MP Modorized	A301R2-0309P	N/A	N/A	Provided by client
B.	Camera	1MAG1NSOU RCE	DMK23GV024	N/A	N/A	Provided by client
C.	Monitor*2	DELL	S2817Q	CN-0GD45P- 74445-6CD-012M- A01	N/A	--
				CN-0GD45P- 74445-6CD-010M- A01	N/A	--
D.	Monitor	DELL	U2410	CN-0J257M- 72872-0A6-02YL	Doc	--
E.	HDD*3	TOSHIBA	DTB305	450KWGVQT3ZB	N/A	--
				45U6CMSST3ZB		
				45U6CMT9T3ZB		
F.	USB Keyboard	DELL	KB216t	CN-0W33XP- LO300-79R- OUG8-A03	N/A	--
G.	USB Mouse	DELL	MOCZUL	CN-049TWY- PRC00-79E-02FY	N/A	--
H.	USB PRINTER	EPSON	T22	MEEZ070220	N/A	--
I.	Notebook*2	DELL	E6440	6QLNM32	N/A	--
				FMLNM32		
J.	RS232 Terminal	N/A	N/A	N/A	N/A	Provided by client
K.	CF Card	7nnodisk	CFast3ME3	N/A	N/A	--
L.	EARPHONE	PHILIPS	SBC HL150	NA	N/A	--
M.	MICROPHONE	Labtec	LVA7313	N/A	N/A	--

Note:

1. All power cords of the above support units are non-shielded (1.8m).
2. Item I acted as communication partner to transfer data.

ID	Descriptions	Qty.	Length (m)	Shielding (Yes/No)	Cores (Qty.)	Remarks
1.	IGN Cable	2	0.55	N	0	
2.	DIO Cable	2	0.9	N	0	
		2	0.3	N	0	
3.	Power Cord	1	1.8	N	0	
4.	DP Cable	2	2.0	Y	0	
5.	VGA Cable	1	2..0	Y	2	
	DVI Cable	1	1.8	Y	2	
6.	USB Cable	3	0.5	Y	0	
7.	Cat5e Cable	4	3.0	N	0	
8.	USB Cable	2	1.8	Y	0	
9.	USB Cable	1	1.8	Y	0	
10.	Cat5e Cable	2	10	N	0	
11.	Adapter Cable	1	1.2	N	1	Accessory of the EUT
12.	Audio Cable	1	1.8	N	0	
13.	Audio Cable	1	1.8	N	0	
14.	Ground Cable	1	2.0	N	0	

Note: The core(s) is(are) originally attached to the cable(s).

Harmonics, Flicker, Immunity tests:

ID	Product	Brand	Model No.	Serial No.	FCC ID	Remarks
A.	Monitor	AOC	240LM00016	GKAJ5HA117767	N/A	--
		Dell	U2414H 23.8" Monitor	CN-04CWX7-74261-47H-4N9L	N/A	--
B.	Monitor	HP	D7Q14A4	CNC437015Q	N/A	--
C.	CF Card	N/A	N/A	N/A	N/A	Provided by client
D.	Keyboard	Logitech	K120	N/A	N/A	--
E.	Mouse	Logitech	M100r	N/A	N/A	--
F.	USB Flash	Transcend	N/A	N/A	N/A	--
G.	Switch Hub	NETGEAR	GS348	N/A	N/A	--
H.	Notebook PC	DELL	Inspiron 15 3000	JVXSD82	N/A	--
		DELL	Inspiron 15 3000	JBXSD82	N/A	--
I.	Earphone	PHILIPS	SHM2100	N/A	N/A	--
J.	Camera*2	3MP Modorized	A301R2-0309P	N/A	N/A	Provided by client
K.	Camera*2	1MAG1NS OURCE	DMK23GV024	N/A	N/A	Provided by client
L.	Load*4	N/A	N/A	N/A	N/A	Provided by client
M.	USB HDD*4	Transcend	TS1T5J25MC	N/A	N/A	--

Note:

1. All power cords of the above support units are non-shielded (1.8m).
2. Item H acted as communication partner to transfer data.

ID	Descriptions	Qty.	Length (m)	Shielding (Yes/No)	Cores (Qty.)	Remarks
1.	Power Cord	1	1.8	N	0	
2.	DVI Cable	1	1.8	Y	2	
3.	DP Cable	2	1.8	Y	0	
4.	Cat5e Cable	2	3.0	N	0	
5.	Audio Cable	1	2.0	N	0	
6.	VGA Cable	1	1.8	Y	2	
7.	DC Cable	1	0.65	N	1	
8.	USB Cable	1	1.5	Y	0	
9.	USB Cable	1	1.8	Y	0	
10.	Cat5e Cable	6	3	N	0	
11.	Camera Cable	2	0.45	Y	0	Provided by client
12.	DIO Cable	2	0.35	N	0	
13.	DIO Cable	2	0.9	N	0	
14.	On / Off Cable	2	0.55	N	0	
15.	USB Cable	4	1.18	Y	0	
16.	GND Cable	1	1.6	N	0	

Note: The core(s) is(are) originally attached to the cable(s).

5 Conducted Disturbance at Auxiliary a.c. or d.c. Power Ports

5.1 Limits

Frequency (MHz)	Quasi-peak, (dBuV)
0.009 - 0.15	no limits
0.15 - 0.5	99
0.5 - 30	93

Notes: 1. The lower limit shall apply at the transition frequencies.
 2. The limit decreases linearly with the logarithm of the frequency in the range of 0.15 to 0.50 MHz.

5.2 Test Instruments

Description & Manufacturer	Model No.	Serial No.	Cal. Date	Cal. Due
Test Receiver ROHDE & SCHWARZ	ESR3	102412	Feb. 14, 2019	Feb. 13, 2020
RF signal cable (with 10dB PAD) Woken	5D-FB	Cable-cond2-01	Sep. 05, 2018	Sep. 04, 2019
LISN ROHDE & SCHWARZ (EUT)	ESH2-Z5	100100	Jan. 30, 2019	Jan. 29, 2020
LISN ROHDE & SCHWARZ (Peripheral)	ESH3-Z5	100312	Aug. 13, 2018	Aug. 12, 2019
Software ADT	BV ADT_Cond_ V7.3.7.4	NA	NA	NA

Note: 1. The calibration interval of the above test instruments is 12 months and the calibrations are traceable to NML/ROC and NIST/USA.
 2. The test was performed in HwaYa Shielded Room 2.
 3. The VCCI Site Registration No. is C-2047.

5.3 Test Arrangement

- The EUT was placed 0.4 meters from the conducting wall of the shielded room with EUT being connected to the power mains through a line impedance stabilization network (LISN). Other support units were connected to the power mains through another LISN. The two LISNs provide 50 Ohm/ 50uH of coupling impedance for the measuring instrument.
- Both lines of the power mains connected to the EUT were checked for maximum conducted interference.
- The test results of conducted emissions at mains ports are recorded of six worst margins for quasi-peak (mandatory) [and average (if necessary)] values against the limits at frequencies of interest unless the margin is 20 dB or greater.

Note: The resolution bandwidth and video bandwidth of test receiver is 9kHz for quasi-peak detection (QP) and average detection (AV) at frequency 0.15MHz-30MHz.

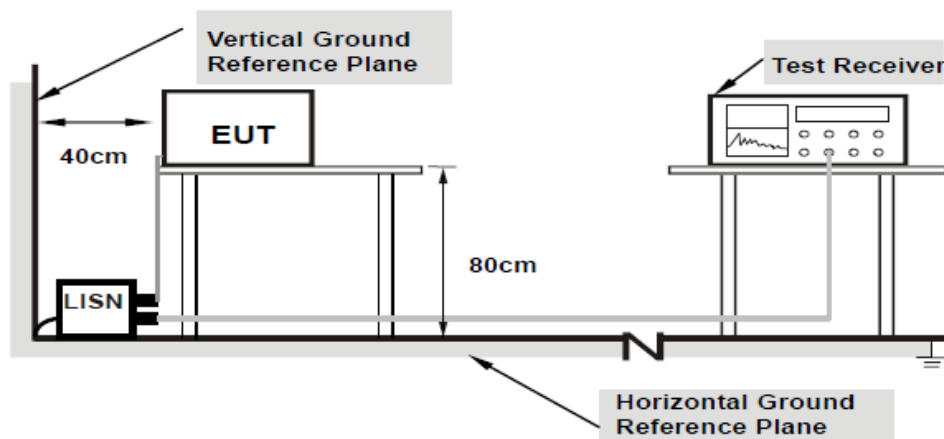

Note: 1. Support units were connected to second LISN.

2. Both of LISNs (AMN) are 80 cm from EUT and at least 80 cm from other units and other metal planes

5.4 Test Results

Frequency Range	150kHz ~ 30MHz	Detector Function & Bandwidth	Quasi-Peak (QP) / Average (AV), 9kHz
Input Power	230Vac, 50Hz	Environmental Conditions	25°C, 60%RH
Tested by	Daniel Lin	Test Date	2019/3/18
Test Mode	Mode 1		

Phase Of Power : Line (L)										
No	Frequency (MHz)	Correction Factor (dB)	Reading Value (dBuV)		Emission Level (dBuV)		Limit (dBuV)		Margin (dB)	
			Q.P.	AV.	Q.P.	AV.	Q.P.	AV.	Q.P.	AV.
1	0.19000	10.07	30.10	13.71	40.17	23.78	79.00	66.00	-38.83	-42.22
2	0.28982	10.07	23.98	11.11	34.05	21.18	79.00	66.00	-44.95	-44.82
3	2.39800	10.10	14.31	5.48	24.41	15.58	73.00	60.00	-48.59	-44.42
4	11.43000	10.31	27.00	18.19	37.31	28.50	73.00	60.00	-35.69	-31.50
5	14.43000	10.39	25.43	18.27	35.82	28.66	73.00	60.00	-37.18	-31.34
6	17.57000	10.46	26.25	20.21	36.71	30.67	73.00	60.00	-36.29	-29.33

Remarks:

1. Q.P. and AV. are abbreviations of quasi-peak and average individually.
2. The emission levels of other frequencies were very low against the limit.
3. Margin value = Emission level – Limit value
4. Correction factor = Insertion loss + Cable loss
5. Emission Level = Correction Factor + Reading Value

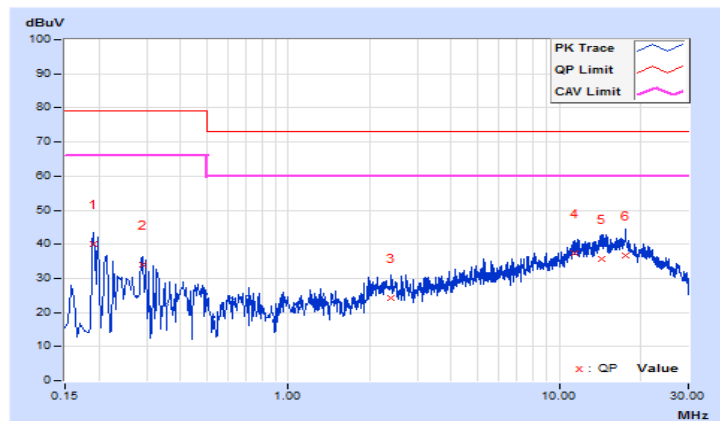

Frequency Range	150kHz ~ 30MHz	Detector Function & Bandwidth	Quasi-Peak (QP) / Average (AV), 9kHz
Input Power	230Vac, 50Hz	Environmental Conditions	25°C, 60%RH
Tested by	Daniel Lin	Test Date	2019/3/18
Test Mode	Mode 1		

Phase Of Power : Neutral (N)										
No	Frequency (MHz)	Correction Factor (dB)	Reading Value (dBuV)		Emission Level (dBuV)		Limit (dBuV)		Margin (dB)	
			Q.P.	AV.	Q.P.	AV.	Q.P.	AV.	Q.P.	AV.
1	0.16579	10.12	33.59	17.61	43.71	27.73	79.00	66.00	-35.29	-38.27
2	0.19000	10.13	31.34	15.27	41.47	25.40	79.00	66.00	-37.53	-40.60
3	0.25405	10.13	26.36	14.87	36.49	25.00	79.00	66.00	-42.51	-41.00
4	5.22200	10.25	17.60	12.59	27.85	22.84	73.00	60.00	-45.15	-37.16
5	18.07400	10.63	29.10	22.17	39.73	32.80	73.00	60.00	-33.27	-27.20
6	24.82200	10.55	28.51	20.82	39.06	31.37	73.00	60.00	-33.94	-28.63

Remarks:

1. Q.P. and AV. are abbreviations of quasi-peak and average individually.
2. The emission levels of other frequencies were very low against the limit.
3. Margin value = Emission level – Limit value
4. Correction factor = Insertion loss + Cable loss
5. Emission Level = Correction Factor + Reading Value

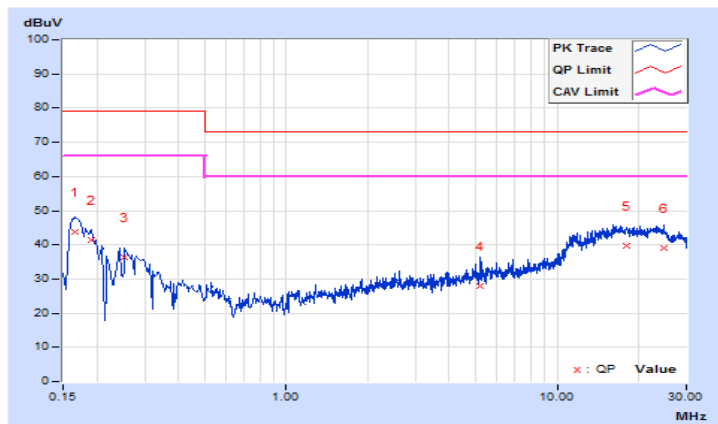

6 Radiated Disturbance up to 1 GHz

6.1 Limits

Frequency (MHz)	dBuV/m (at 10m) / quasi-peak
30 - 230	40
230 - 1000	47

- Notes: 1. The lower limit shall apply at the transition frequencies.
 2. Emission level (dBuV/m) = 20 log Emission level (uV/m).
 3. All emanations from a class A/B digital device or system, including any network of conductors and apparatus connected thereto, shall not exceed the level of field strengths specified above.

6.2 Test Instruments

Description & Manufacturer	Model No.	Serial No.	Cal. Date	Cal. Due
Test Receiver ROHDE & SCHWARZ (V)	ESR	101240	Oct. 30, 2018	Oct. 29, 2019
Test Receiver ROHDE & SCHWARZ (H)	ESR3	102412	Feb. 14, 2019	Feb. 13, 2020
BILOG Antenna SCHWARZBECK (V)	VULB9168	9168-148	Nov. 20, 2018	Nov. 19, 2019
BILOG Antenna SCHWARZBECK (H)	VULB9168	9168-156	Nov. 20, 2018	Nov. 19, 2019
Preamplifier Sonoma (V)	310N	352924	Jul. 12, 2018	Jul. 11, 2019
Preamplifier Sonoma (H)	310N	352923	Jul. 12, 2018	Jul. 11, 2019
RF signal cable (with 5dB PAD) Times (V)	LMR-600 (18M) +LMR-400 (7M)	CABLE-CH1 (VER) -01	Oct. 03, 2018	Oct. 02, 2019
RF signal cable (with 5dB PAD) Times (H)	LMR-600 (11.8M) +LMR-400 (7M)	CABLE-CH1 (HOR) -01	Oct. 03, 2018	Oct. 02, 2019
Software BV ADT	BV ADT_Radiated_ V8.7.08	NA	NA	NA
Antenna Tower (V)	MFA-440	9707	NA	NA
Antenna Tower (H)	MFA-440	970705	NA	NA
Turn Table	DS430	50303	NA	NA
Controller (V)	MF7802	074	NA	NA
Controller (H)	MF7802	08093	NA	NA

- NOTE: 1. The calibration interval of the above test instruments is 12 months and the calibrations are traceable to NML/ROC and NIST/USA.
 2. The test was performed in HwaYa Chamber 1.
 3. The IC Site Registration No. is IC 7450F-1.
 4. The VCCI Site Registration No. is R-1893.

6.3 Test Arrangement

- The EUT was placed on the top of a rotating table 0.8 meters above the ground at an accredited test facility. The table was rotated 360 degrees to determine the position of the highest radiation.
- The EUT was set 10 meters away from the interference-receiving antenna, which was mounted on the top of a variable-height antenna tower.
- The antenna is a broadband antenna, and its height is varied from one meter to four meters above the ground to determine the maximum value of the field strength. Both horizontal and vertical polarizations of the antenna are set to make the measurement.
- For each suspected emission, the EUT was arranged to its worst case and then the antenna was tuned to heights from 1 meter to 4 meters and the rotatable table was turned from 0 degrees to 360 degrees to find the maximum reading.
- The test-receiver system was set to quasi-peak detect function and specified bandwidth with maximum hold mode when the test frequency is up to 1 GHz.

Note: The resolution bandwidth and video bandwidth of test receiver/spectrum analyzer is 120 kHz for quasi-peak detection (QP) at frequency up to 1 GHz.

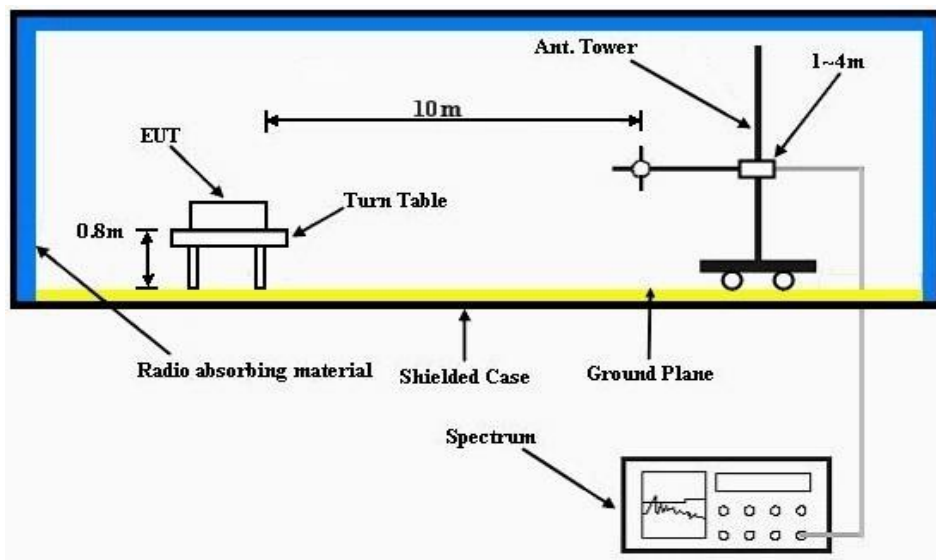

6.4 Test Results

Frequency Range	30MHz ~ 1GHz	Detector Function & Bandwidth	Quasi-Peak (QP), 120kHz
Test Mode	Mode 1	Environmental Conditions	22°C, 65%RH
Tested by	Jim Lee	Test Date	2019/3/18

Antenna Polarity & Test Distance : Horizontal at 10 m								
No	Frequency (MHz)	Emission Level (dBuV/m)	Limit (dBuV/m)	Margin (dB)	Antenna Height (m)	Table Angle (Degree)	Raw Value (dBuV)	Correction Factor (dB/m)
1	375.00	40.28 QP	47.00	-6.72	2.00 H	293	51.57	-11.29
2	400.03	35.87 QP	47.00	-11.13	4.00 H	175	45.10	-9.23
3	625.03	36.30 QP	47.00	-10.70	2.50 H	137	40.79	-4.49
4	744.00	36.45 QP	47.00	-10.55	3.00 H	211	39.89	-3.44
5	792.02	35.02 QP	47.00	-11.98	4.00 H	330	36.55	-1.53
6	884.22	39.04 QP	47.00	-7.96	2.00 H	65	40.26	-1.22

Remarks:

1. Emission Level(dBuV/m) = Raw Value(dBuV) + Correction Factor(dB/m)
2. Correction Factor(dB/m) = Antenna Factor (dB/m) + Cable Factor (dB) – Pre-Amplifier Factor (dB)
3. The other emission levels were very low against the limit.
4. Margin value = Emission level – Limit value

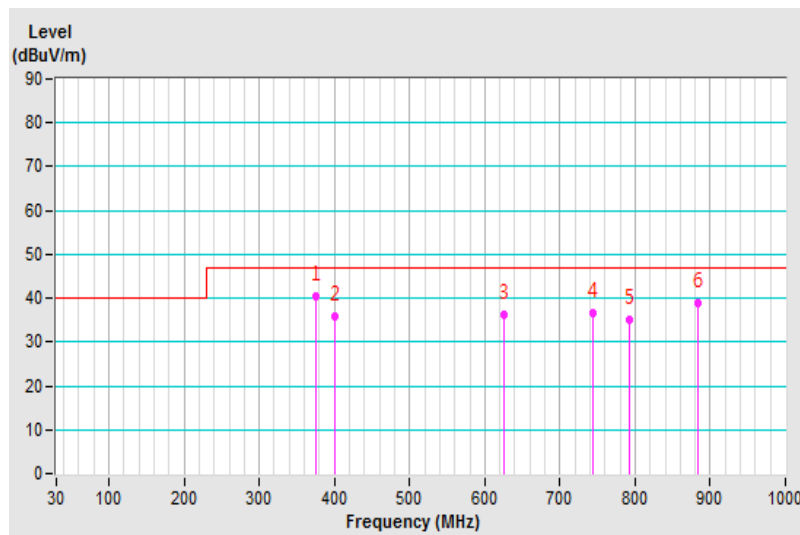

Frequency Range	30MHz ~ 1GHz	Detector Function & Bandwidth	Quasi-Peak (QP), 120kHz
Test Mode	Mode 1	Environmental Conditions	22°C, 65%RH
Tested by	Jim Lee	Test Date	2019/3/18

Antenna Polarity & Test Distance : Vertical at 10 m								
No	Frequency (MHz)	Emission Level (dBuV/m)	Limit (dBuV/m)	Margin (dB)	Antenna Height (m)	Table Angle (Degree)	Raw Value (dBuV)	Correction Factor (dB/m)
1	34.80	36.54 QP	40.00	-3.46	1.00 V	2	51.70	-15.16
2	75.93	32.22 QP	40.00	-7.78	2.00 V	352	49.17	-16.95
3	121.52	33.11 QP	40.00	-6.89	2.50 V	83	48.90	-15.79
4	156.93	32.72 QP	40.00	-7.28	4.00 V	77	45.78	-13.06
5	304.72	38.04 QP	47.00	-8.96	2.00 V	98	50.04	-12.00
6	328.14	40.77 QP	47.00	-6.23	2.00 V	284	51.25	-10.48
7	375.00	43.88 QP	47.00	-3.12	1.00 V	318	54.70	-10.82

Remarks:

1. Emission Level(dBuV/m) = Raw Value(dBuV) + Correction Factor(dB/m)
2. Correction Factor(dB/m) = Antenna Factor (dB/m) + Cable Factor (dB) - Pre-Amplifier Factor (dB)
3. The other emission levels were very low against the limit.
4. Margin value = Emission level - Limit value

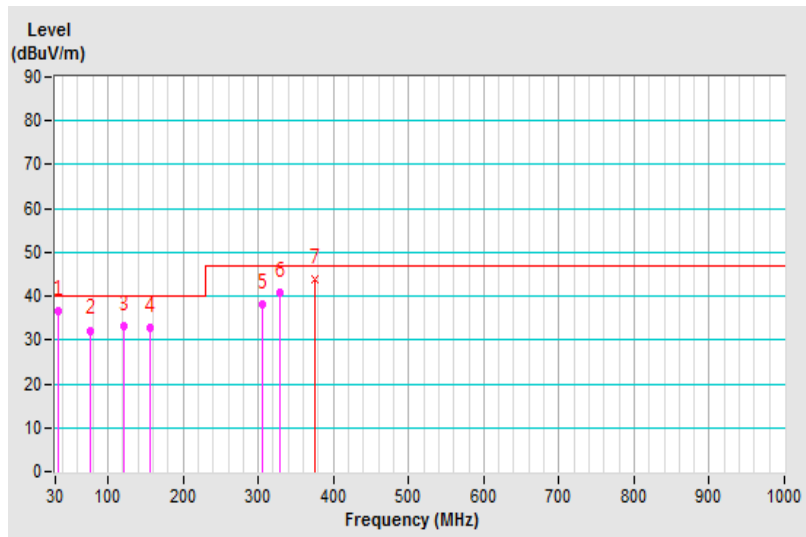

7 Radiated Disturbance above 1 GHz

7.1 Limits

Frequency (GHz)	Class A (dBuV/m) (at 3 m)		Class B (dBuV/m) (at 3 m)	
	Average	Peak	Average	Peak
1 to 3	56	76	50	70
3 to 6	60	80	54	74

Notes:

1. The lower limit shall apply at the transition frequencies.
2. Emission level (dBuV/m) = 20 log Emission level (uV/m).
3. All emanations from a class A/B digital device or system, including any network of conductors and apparatus connected thereto, shall not exceed the level of field strengths specified above.

Frequency Range (For unintentional radiators)

Highest frequency generated or used in the EUT or on which the EUT operates or tunes (MHz)	Upper frequency of measurement range (MHz)
Below 108	1000
108-500	2000
500-1000	5000
Above 1000	Up to 5 times of the highest frequency or 6 GHz, whichever is less

7.2 Test Instruments

Description & Manufacturer	Model No.	Serial No.	Cal. Date	Cal. Due
Test Receiver ROHDE & SCHWARZ (Above 1GHz)	ESR7	101471	Mar. 07, 2019	Mar. 06, 2020
Spectrum Analyzer Agilent	E4446A	MY51100039	Sep. 10, 2018	Sep. 09, 2019
RF signal cable (with 5dB PAD) Times	LMR-400 (18M)	CABLE-CH2-01	Apr. 27, 2018	Apr. 26, 2019
HORN Antenna (with 4dB PAD) SCHWARZBECK	BBHA 9120 D	9120D-405	Nov. 25, 2018	Nov. 24, 2019
Pre-Amplifier Agilent (Above 1GHz)	8449B	3008A01961	Oct. 15, 2018	Oct. 14, 2019
RF Coaxial Cable JUNFLON+EMC	JUNFLON+EMC10 4-SM-SM-6000	Cable-CH2- 02(MWX3221308G003+1307 10)	Jun. 11, 2018	Jun. 10, 2019
Software BV ADT	BV ADT_Radiated_ V8.7.08	NA	NA	NA
Antenna Tower BV ADT	AT100	AT93021702	NA	NA
Turn Table BV ADT	TT100	TT93021702	NA	NA
Controller BV ADT	SC100	SC93021702	NA	NA
BandPass Filter (2.4G) MICRO-TRONICS	BRM17690-01	003	Sep. 12, 2018	Sep. 11, 2019
BandPass Filter (5G) MICRO-TRONICS	BRM50716-01	G011	Sep. 12, 2018	Sep. 11, 2019

- Note: 1. The calibration interval of the above test instruments is 12 months and the calibrations are traceable to NML/ROC and NIST/USA.
2. The test was performed in HwaYa Chamber 2.
3. The horn antenna and preamplifier (model: 8449B) are used only for the measurement of emission frequency above 1GHz if tested.
4. The IC Site Registration No. is IC 7450F-2.
5. The VCCI Site Registration No. is G-10018.

7.3 Test Arrangement

- The EUT was placed on the top of a rotating table 0.8 meters above the ground at an accredited chamber room. The table was rotated 360 degrees to determine the position of the highest radiation.
- The EUT was set 3 meters away from the interference-receiving antenna, which was mounted on the top of a variable-height antenna tower.
- The height of antenna can be varied from one meter to four meters, the height of adjustment depends on the EUT height and the antenna 3 dB beamwidth both, to detect the maximum value of the field strength. Both horizontal and vertical polarizations of the antenna are set to make the measurement.
- For each suspected emission, the EUT was arranged to its worst case and then the antenna was tuned to heights and the rotatable table was turned from 0 degrees to 360 degrees to find the maximum reading.
- The spectrum analyzer system was set to peak and average detect function and specified bandwidth with maximum hold mode when the test frequency is above 1 GHz.

Note: The resolution bandwidth of test receiver/spectrum analyzer is 1 MHz and video bandwidth is 3 MHz for Peak detection (PK) at frequency above 1 GHz. The resolution bandwidth of test receiver/spectrum analyzer is 1 MHz for Average detection (AV) at frequency above 1 GHz.

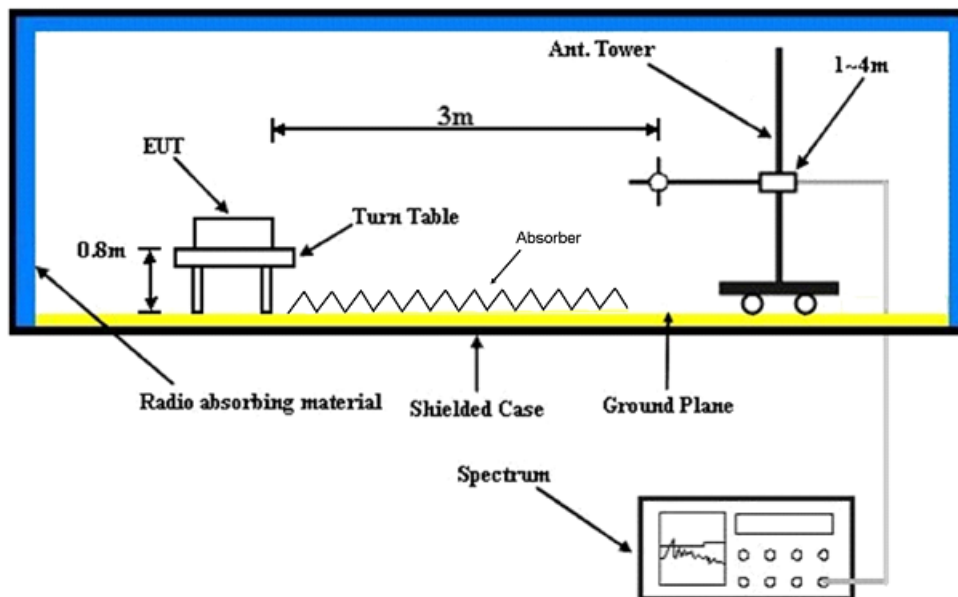

Note: According to EN 55032 standard, cables on the RGP must be insulated.

7.4 Test Results

Frequency Range	1GHz ~ 6GHz	Detector Function & Bandwidth	Peak (PK) / Average (AV), 1MHz
Test Mode	Mode 1	Environmental Conditions	20°C, 60%RH
Tested by	Kai Chu	Test Date	2019/4/12

Antenna Polarity & Test Distance : Horizontal at 3 m								
No	Frequency (MHz)	Emission Level (dBuV/m)	Limit (dBuV/m)	Margin (dB)	Antenna Height (m)	Table Angle (Degree)	Raw Value (dBuV)	Correction Factor (dB/m)
1	1416.98	55.59 PK	76.00	-20.41	1.47 H	193	56.97	-1.38
2	1416.98	39.45 AV	56.00	-16.55	1.47 H	193	40.83	-1.38
3	1946.18	57.72 PK	76.00	-18.28	2.03 H	16	57.56	0.16
4	1946.18	39.74 AV	56.00	-16.26	2.03 H	16	39.58	0.16
5	2414.97	57.49 PK	76.00	-18.51	1.00 H	357	54.74	2.75
6	2414.97	47.18 AV	56.00	-8.82	1.00 H	357	44.43	2.75
7	2587.68	53.21 PK	76.00	-22.79	1.00 H	346	50.40	2.81
8	2587.68	40.49 AV	56.00	-15.51	1.00 H	346	37.68	2.81
9	2890.16	58.21 PK	76.00	-17.79	2.47 H	239	54.37	3.84
10	2890.16	38.57 AV	56.00	-17.43	2.47 H	239	34.73	3.84

Remarks:

1. Emission Level(dBuV/m) = Raw Value(dBuV) + Correction Factor(dB/m)
2. Correction Factor(dB/m) = Antenna Factor (dB/m) + Cable Factor (dB) – Pre-Amplifier Factor (dB)
3. The other emission levels were very low against the limit.
4. Margin value = Emission level – Limit value

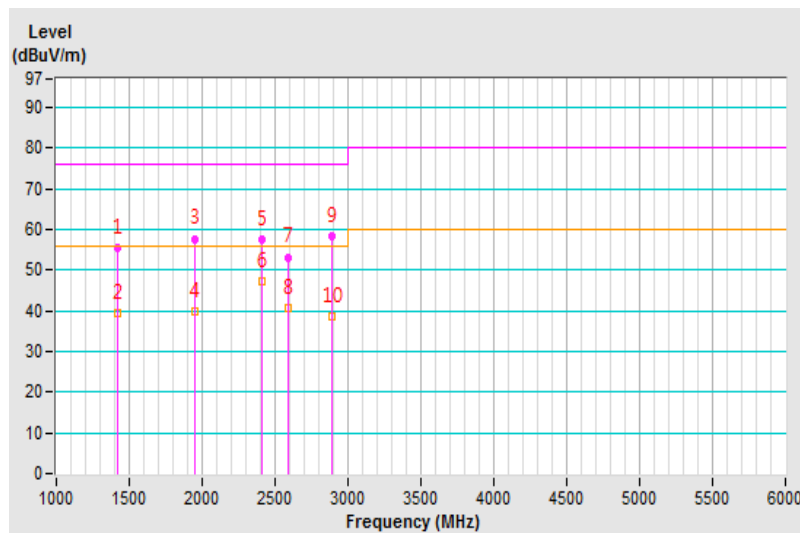

Frequency Range	1GHz ~ 6GHz	Detector Function & Bandwidth	Peak (PK) / Average (AV), 1MHz
Test Mode	Mode 1	Environmental Conditions	20°C, 60%RH
Tested by	Kai Chu	Test Date	2019/4/12

Antenna Polarity & Test Distance : Vertical at 3 m								
No	Frequency (MHz)	Emission Level (dBuV/m)	Limit (dBuV/m)	Margin (dB)	Antenna Height (m)	Table Angle (Degree)	Raw Value (dBuV)	Correction Factor (dB/m)
1	1413.98	55.11 PK	76.00	-20.89	1.00 V	20	56.47	-1.36
2	1413.98	39.80 AV	56.00	-16.20	1.00 V	20	41.16	-1.36
3	1951.43	58.96 PK	76.00	-17.04	1.00 V	199	58.78	0.18
4	1951.43	40.41 AV	56.00	-15.59	1.00 V	199	40.23	0.18
5	2415.03	57.77 PK	76.00	-18.23	3.03 V	317	55.02	2.75
6	2415.03	49.61 AV	56.00	-6.39	3.03 V	317	46.86	2.75
7	2890.15	56.48 PK	76.00	-19.52	1.97 V	142	52.64	3.84
8	2890.15	38.16 AV	56.00	-17.84	1.97 V	142	34.32	3.84

Remarks:

1. Emission Level(dBuV/m) = Raw Value(dBuV) + Correction Factor(dB/m)
2. Correction Factor(dB/m) = Antenna Factor (dB/m) + Cable Factor (dB) – Pre-Amplifier Factor (dB)
3. The other emission levels were very low against the limit.
4. Margin value = Emission level – Limit value

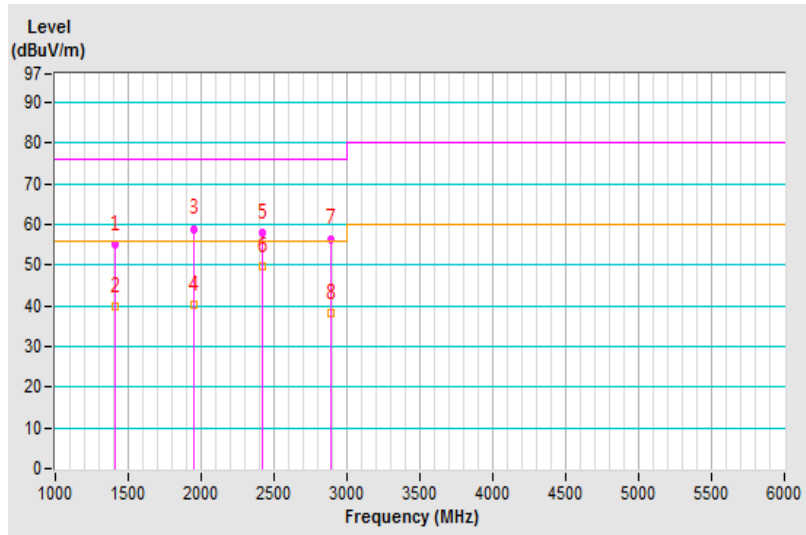

8 Electrostatic Discharge Immunity Test (ESD)

8.1 Test Specification

Basic Standard:	EN/IEC 61000-4-2
Discharge Impedance:	330 ohm / 150 pF
Discharge Voltage:	Air Discharge: $\pm 2, \pm 4, \pm 8$ kV (Direct) Contact Discharge: $\pm 2, \pm 4$ kV, ± 6 kV (Direct/Indirect)
Number of Discharge:	Minimum 20 times at each test point
Discharge Mode:	Single Discharge
Discharge Period:	1-second minimum

8.2 Test Instruments

Description & Manufacturer	Model No.	Serial No.	Cal. Date	Cal. Due
EM Test ESD Generator	Dito//DM-150/330//DM-150/330-rfci	P1315117252	Jul. 31, 2018	Jul. 30, 2019

- Notes:
1. The test was performed in Hwa Ya ESD Room 3.
 2. The calibration interval of the above test instruments is 12 months and the calibrations are traceable to NML/ROC and NIST/USA.

8.3 Test Arrangement

- a. Electrostatic discharges were applied only to those points and surfaces of the EUT that are accessible to users during normal operation.
- b. The test was performed with at least ten single discharges on the pre-selected points in the most sensitive polarity.
- c. The time interval between two successive single discharges was at least 1 second.
- d. The ESD generator was held perpendicularly to the surface to which the discharge was applied and the return cable was at least 0.2 meters from the EUT.
- e. Contact discharges were applied to the non-insulating coating, with the pointed tip of the generator penetrating the coating and contacting the conducting substrate.
- f. Air discharges were applied with the round discharge tip of the discharge electrode approaching the EUT as fast as possible (without causing mechanical damage) to touch the EUT. After each discharge, the ESD generator was removed from the EUT and re-triggered for a new single discharge. The test was repeated until all discharges were complete.
- g. At least ten single discharges (in the most sensitive polarity) were applied to the **Horizontal Coupling Plane** at points on each side of the EUT. The ESD generator was positioned at a distance of 0.1 meters from the EUT with the discharge electrode touching the **HCP**.
- h. At least ten single discharges (in the most sensitive polarity) were applied to the center of one vertical edge of the **Vertical Coupling Plane** in sufficiently different positions that the four faces of the EUT were completely illuminated. The **VCP** (dimensions 0.5m x 0.5m) was placed vertically to and 0.1 meters from the EUT.

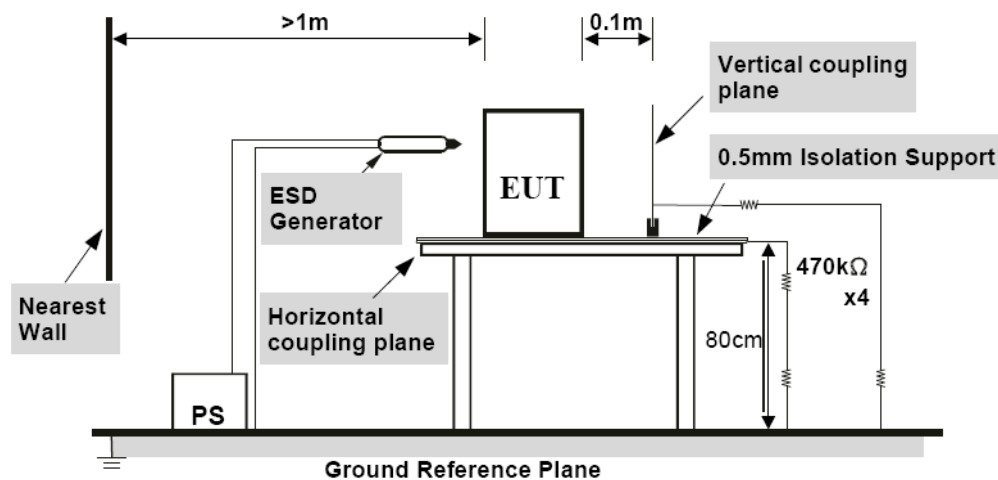

8.4 Test Results

Input Power	230 Vac, 50 Hz	Tested by	Evan Liao
Environmental Conditions	23 °C, 40% RH 988 mbar	Test Date	2019/03/26
Test mode	1		

Test Results of Direct Application

Discharge Level (kV)	Polarity (+/-)	Test Point	Contact Discharge	Air Discharge	Performance Criterion
2, 4, 8	+/-	10-12	N/A	Note 1	A
2, 4, 6	+/-	1-9	Note 1	N/A	A

Description of test points of direct application: Please refer to following page for representative mark only.

Test Results of Indirect Application

Discharge Level (kV)	Polarity (+/-)	Test Point	Horizontal Coupling Plane	Vertical Coupling Plane	Performance Criterion
2, 4, 6	+/-	Four Sides	Note 1	Note 1	A

Description of test points of indirect application:

1. Front side 2. Rear side 3. Right side 4. Left side

Note: 1. The EUT function was correct during the test.

Description of Test Points

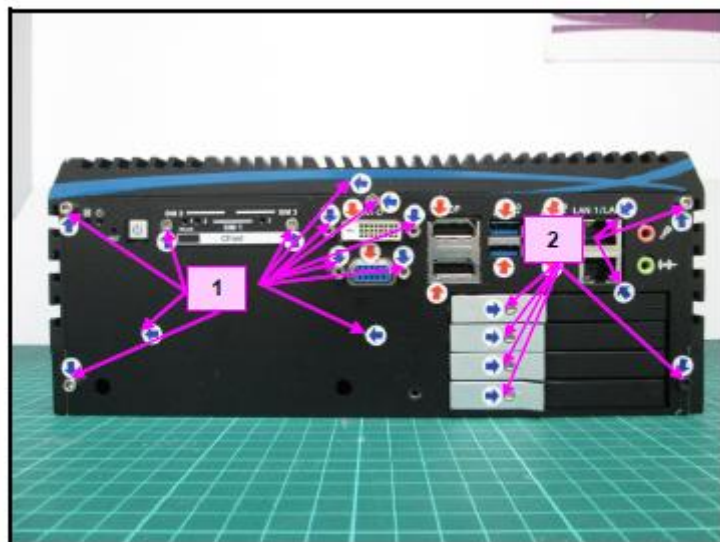
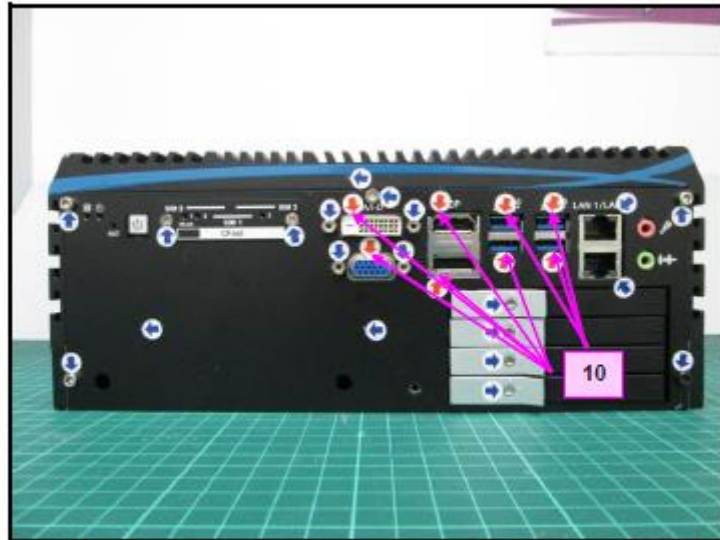

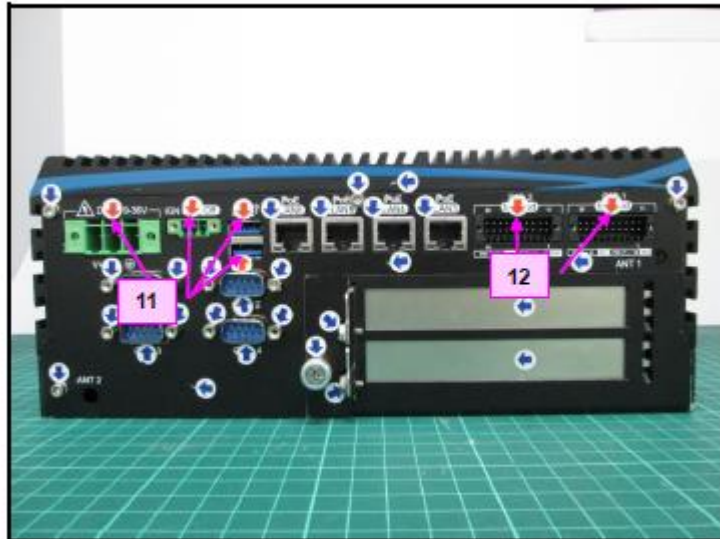

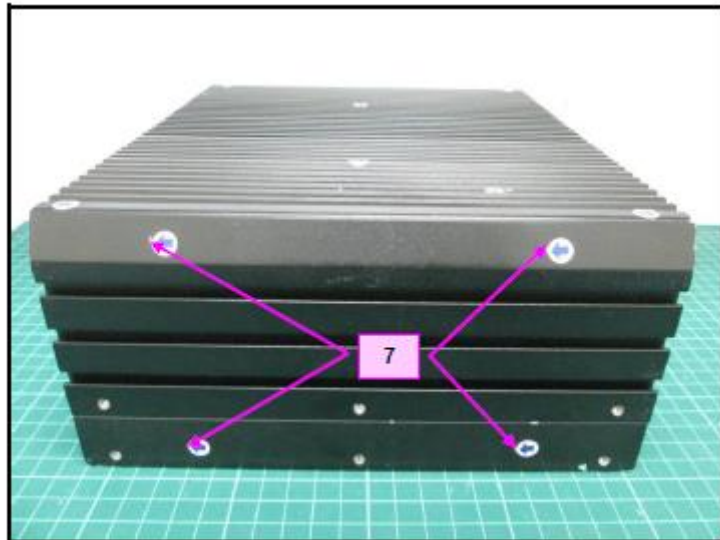
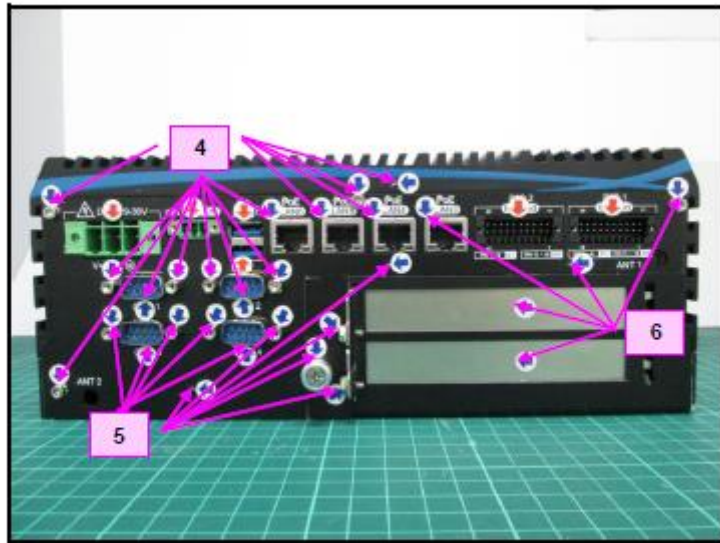

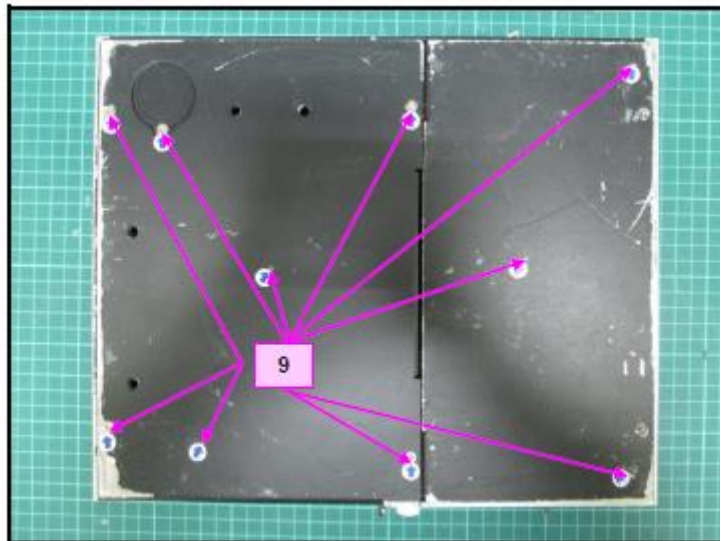
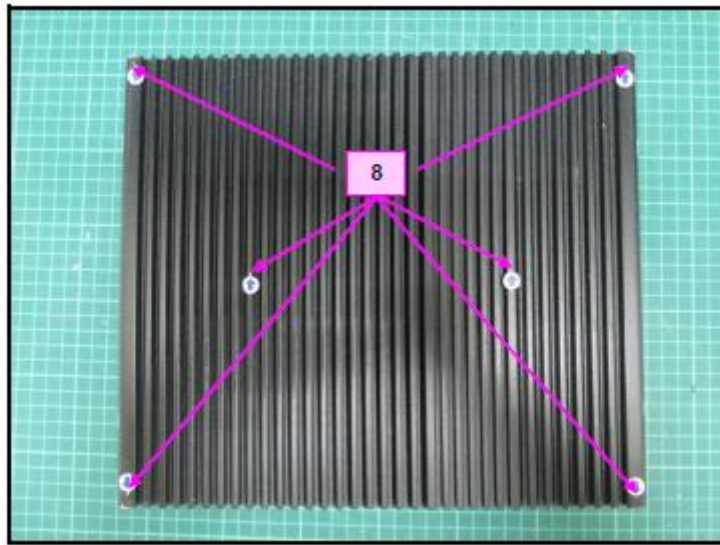

Input Power	230 Vac, 50 Hz	Tested by	Evan Liao
Environmental Conditions	23 °C, 40% RH 988 mbar	Test Date	2019/03/26
Test mode	2		

Test Results of Direct Application					
Discharge Level (kV)	Polarity (+/-)	Test Point	Contact Discharge	Air Discharge	Performance Criterion
2, 4, 8	+/-	10-12	N/A	Note 1	A
2, 4, 6	+/-	1-9	Note 1	N/A	A

Description of test points of direct application: Please refer to following page for representative mark only.

Test Results of Indirect Application					
Discharge Level (kV)	Polarity (+/-)	Test Point	Horizontal Coupling Plane	Vertical Coupling Plane	Performance Criterion
2, 4, 6	+/-	Four Sides	Note 1	Note 1	A

Description of test points of indirect application:

1. Front side 2. Rear side 3. Right side 4. Left side

Note: 1. The EUT function was correct during the test.

Description of Test Points

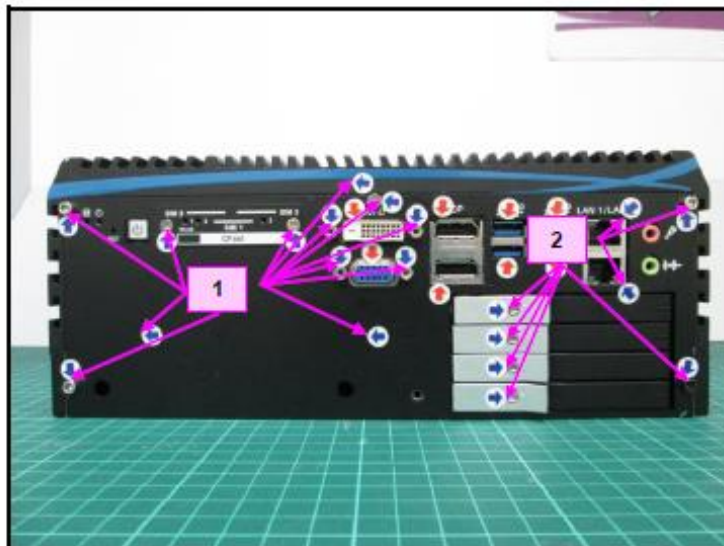
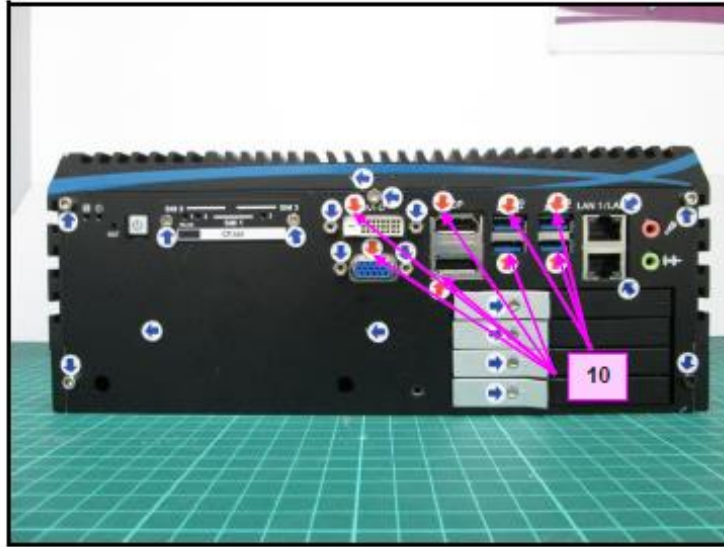

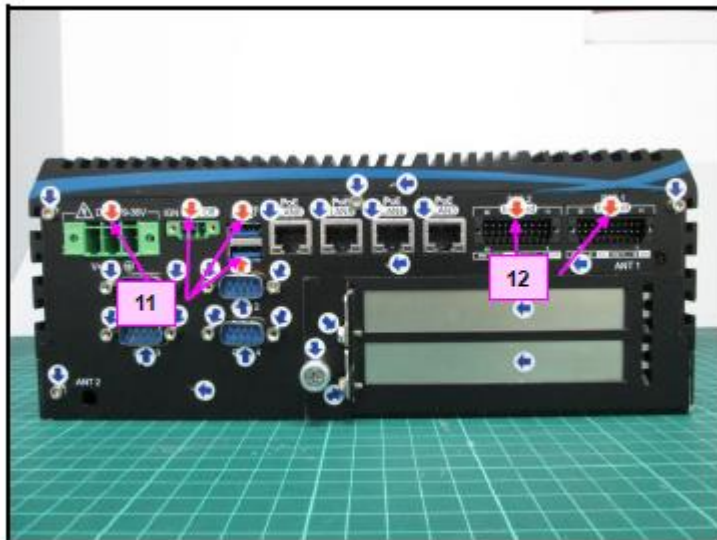
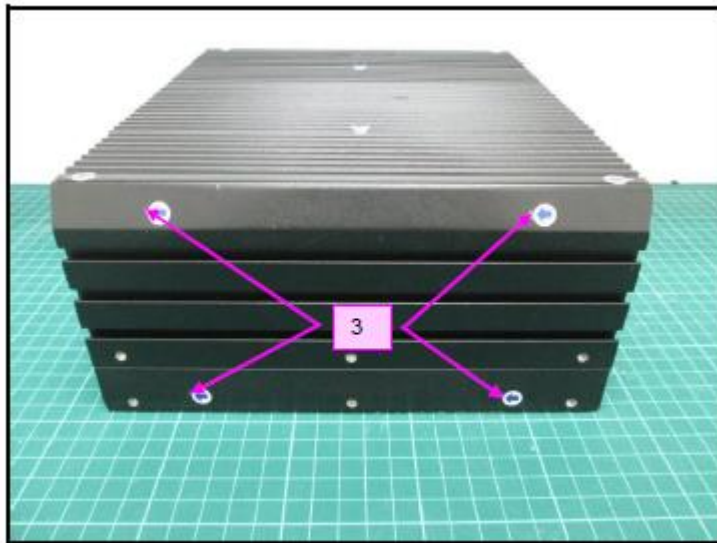

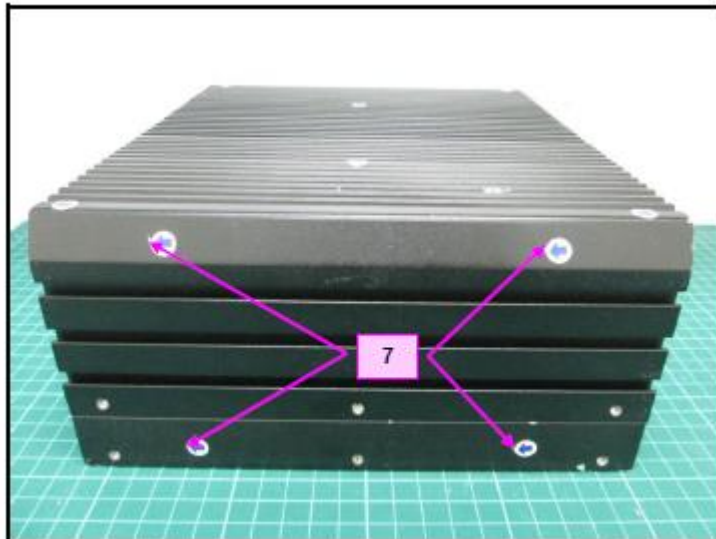
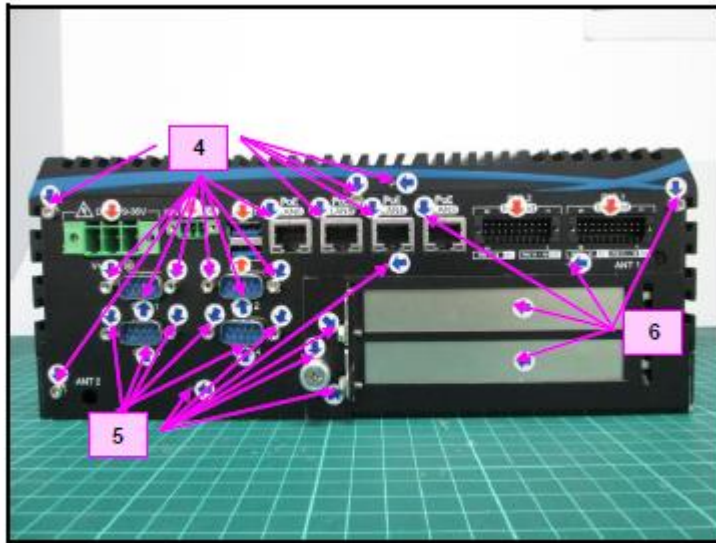

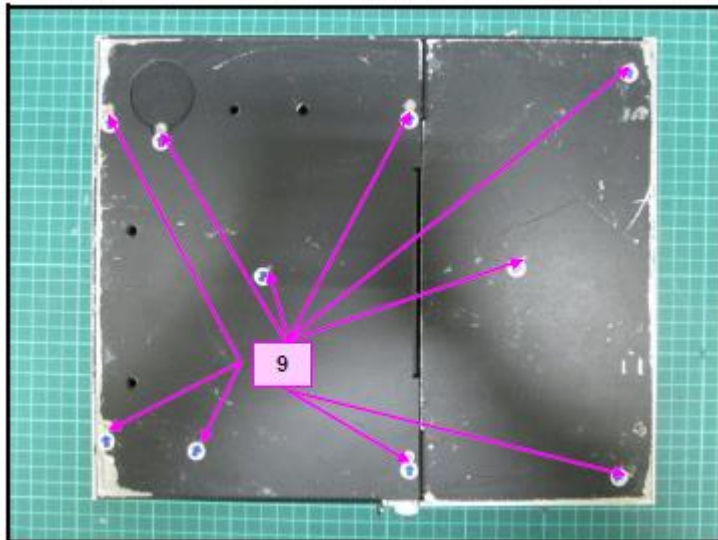
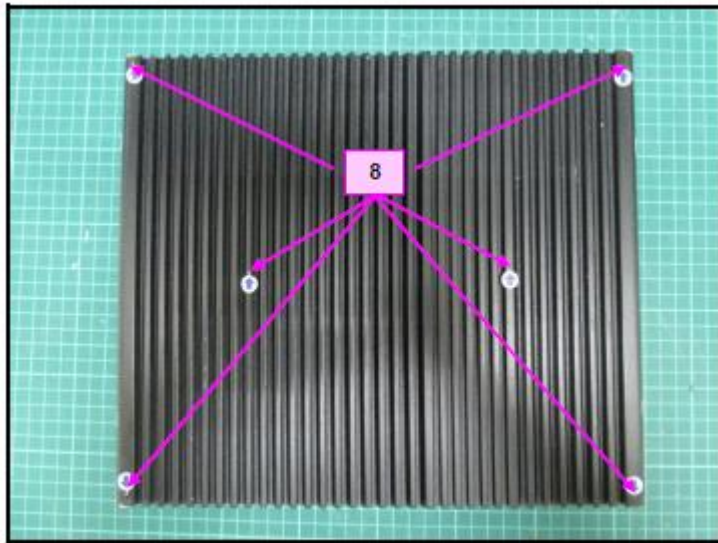

Input Power	230 Vac, 50 Hz	Tested by	Regan Wang
Environmental Conditions	23 °C, 40% RH 988 mbar	Test Date	2019/03/26
Test mode	3		

Test Results of Direct Application					
Discharge Level (kV)	Polarity (+/-)	Test Point	Contact Discharge	Air Discharge	Performance Criterion
2, 4, 8	+/-	10-12	N/A	Note 1	A
2, 4, 6	+/-	1-9	Note 1	N/A	A

Description of test points of direct application: Please refer to following page for representative mark only.

Test Results of Indirect Application					
Discharge Level (kV)	Polarity (+/-)	Test Point	Horizontal Coupling Plane	Vertical Coupling Plane	Performance Criterion
2, 4, 6	+/-	Four Sides	Note 1	Note 1	A

Description of test points of indirect application:

1. Front side 2. Rear side 3. Right side 4. Left side

Note: 1. The EUT function was correct during the test.

Description of Test Points

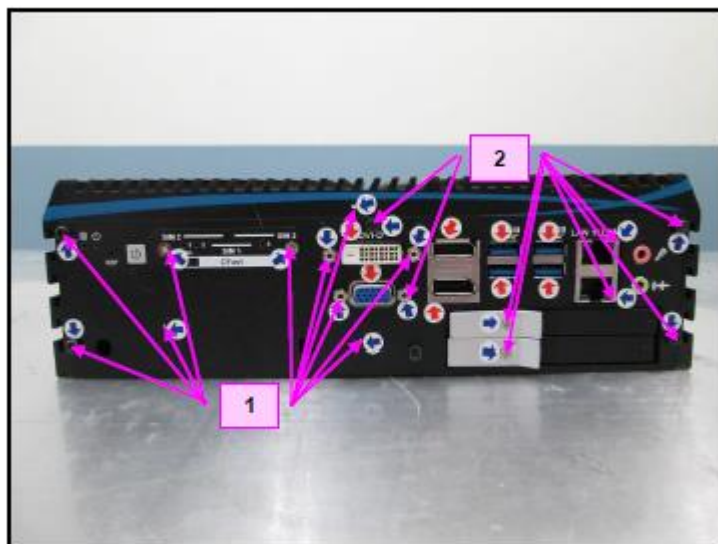
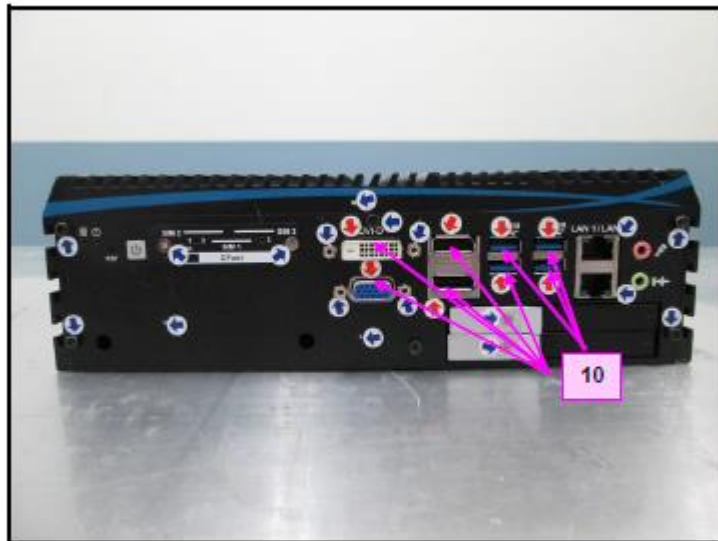

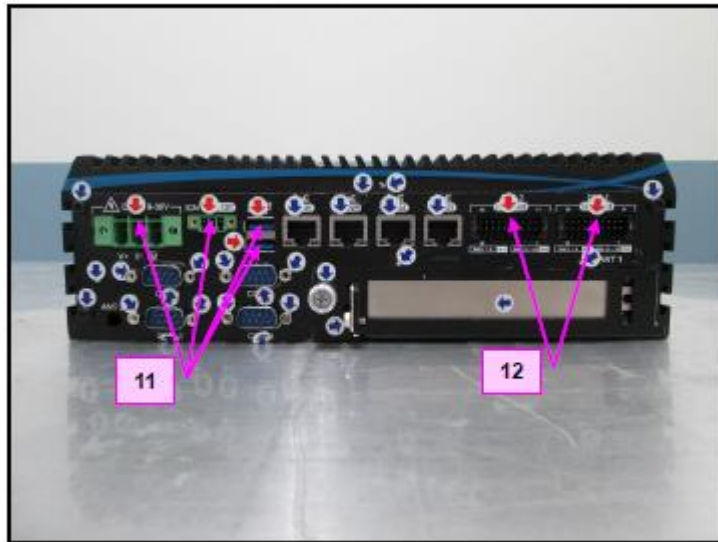
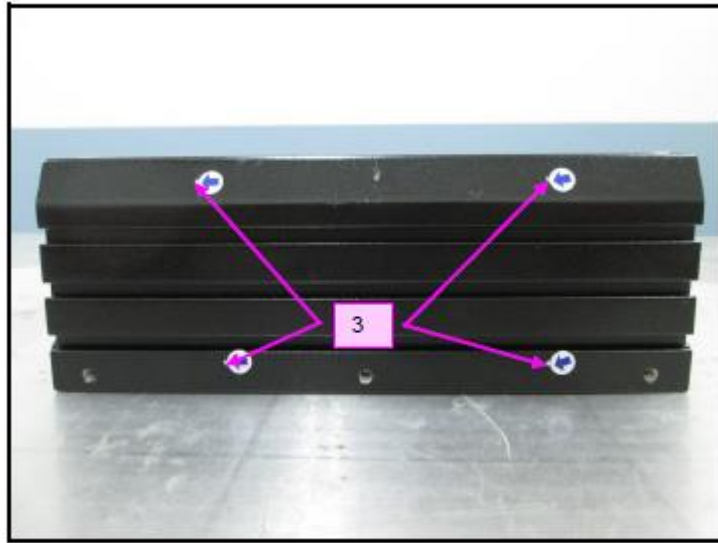

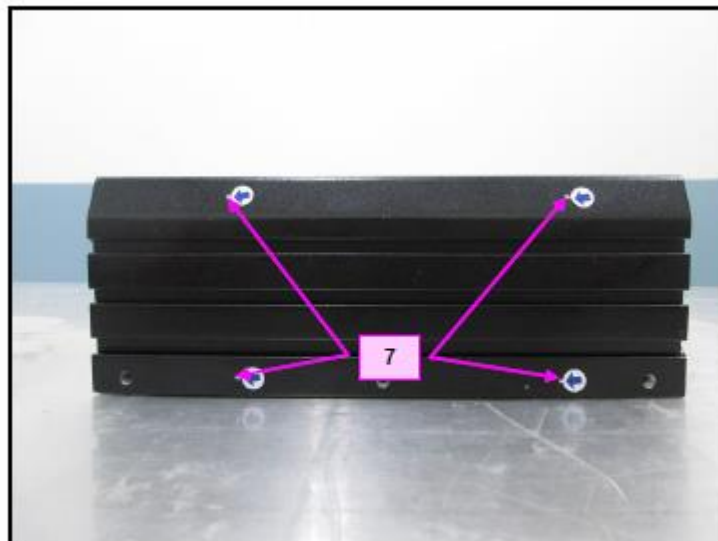
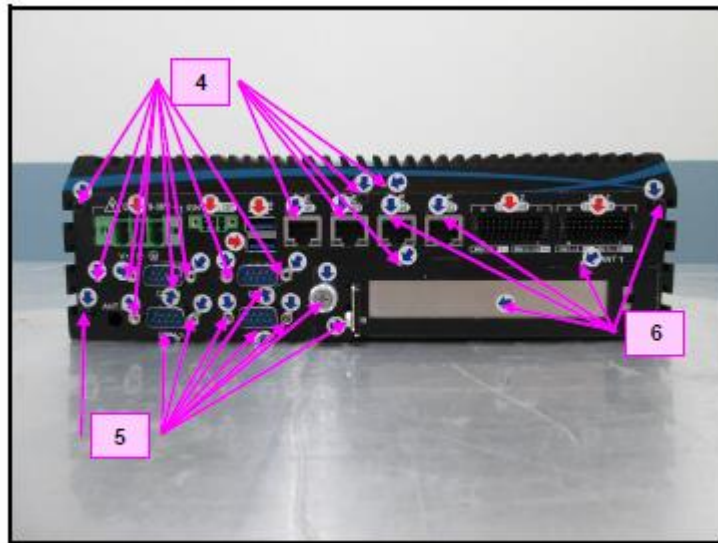

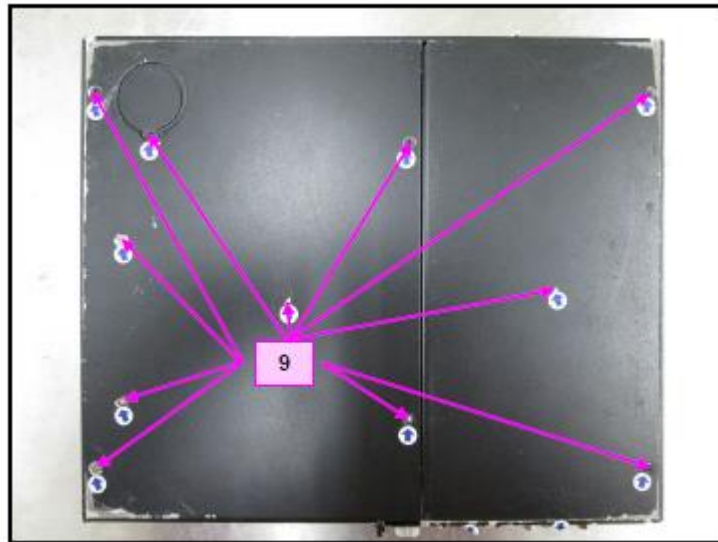
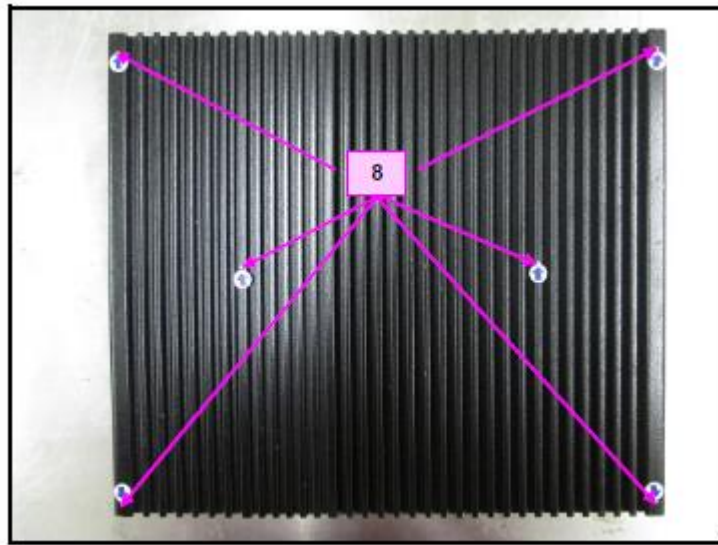

9 Radio-frequency Electromagnetic Field Immunity Test (RS)

9.1 Test Specification

Basic Standard:	EN/IEC 61000-4-3 80-1000 MHz, 20V/m ¹
Frequency Range, Field Strength:	1400-2000 MHz, 10V/m 2100-2700 MHz, 5V/m 5100-6000 MHz, 3V/m
Modulation:	1kHz Sine Wave, 80%, AM Modulation
Frequency Step:	1 % of preceding frequency value
Polarity of Antenna:	Horizontal and Vertical
Antenna Height:	1.5m
Dwell Time:	3 seconds

Note 1: This limit applies to equipment mounted in the passenger compartments, drivers cab or external to the rolling stock (roof, underframe). For equipment mounted in all other areas a severity level of 10 V/m may be used.

9.2 Test Instruments

Description & Manufacturer	Model No.	Serial No.	Cal. Date	Cal. Due
BONN Power Amp	BLMA 1060-100/50D	118694	NA	NA
BBA Power Amp	B250C125	101011	NA	NA
Power Sensor	NRP-Z91	101572	Jan. 24, 2019	Jan. 23, 2020
Power Sensor	NRP-Z91	101573	Jan. 18, 2019	Jan. 17, 2020
Signal Generator	SMB100A	105801	Jan. 17, 2019	Jan. 16, 2020
R&S Software	EMC32 Version 8.52.0	NA	NA	NA
Stacked Log-Per Antenna	STLP9149	9149-141	NA	NA
High GAIN LOG-Periodic Antenna	HL046E	100114	NA	NA

- Notes:
1. The test was performed in Hwa Ya RS Room 2.
 2. The calibration interval of the above test instruments is 12 months and the calibrations are traceable to NML/ROC and NIST/USA.
 3. The transmit antenna was located at a distance of 3 meters from the EUT.

9.3 Test Arrangement

The test procedure was in accordance with EN/IEC 61000-4-3.

- a. The testing was performed in a fully chamber.
- b. The frequency ranges and field strength levels are 80-1000 MHz, 20V/m, 1400-2100 MHz, 10V/m, 2100-2500 MHz, 5V/m, 3V/m with the signal 80% amplitude modulated with a 1kHz sine wave.
- c. The test was performed with the EUT exposed to both vertically and horizontally polarized fields on each of the four sides (We have pretested all test modes at front (0°) side to select the worst mode. According to the pretest result, only the worst mode was tested at four sides and other modes were tested at front side according to the worst side tested at pretested.)

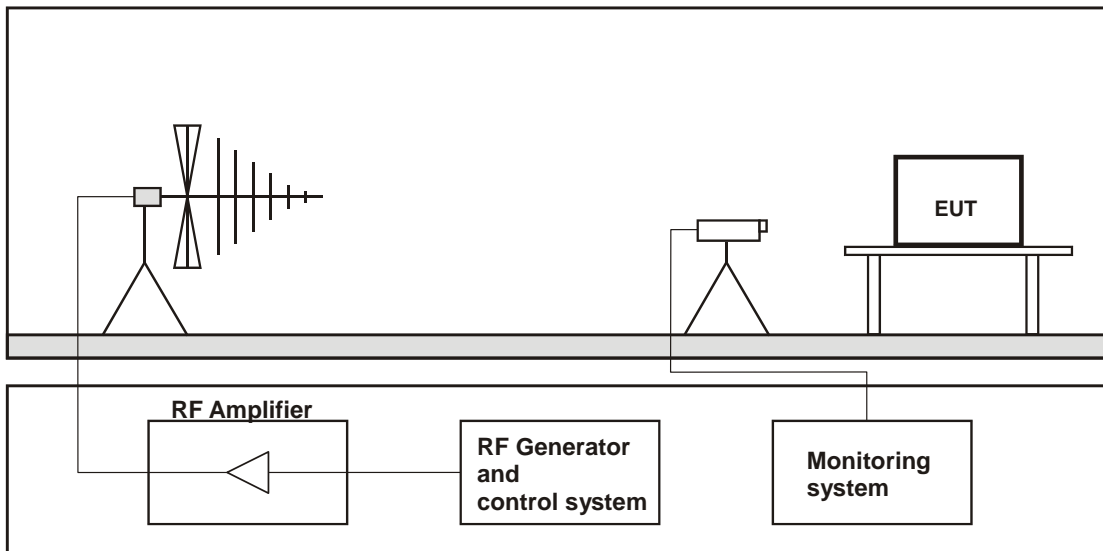

9.4 Test Results

Input Power	230 Vac, 50 Hz	Tested by	Evan Liao
Environmental Conditions	23 °C, 58% RH	Test Date	2019/03/14
Test mode	1		

Frequency (MHz)	Polarity	Azimuth(°)	Applied Field Strength		Observation	Test Distance (m)	Performance Criterion
			(V/m)	Modulation			
80 - 1000	V&H	0, 90, 180, 270	20	80% AM (1kHz)	Note 1	3	A
1400 - 2000	V&H	0, 90, 180, 270	10	80% AM (1kHz)	Note 1	3	A
2000 - 2700	V&H	0, 90, 180, 270	5	80% AM (1kHz)	Note 1	3	A
5100 - 6000	V&H	0, 90, 180, 270	3	80% AM (1kHz)	Note 1	3	A

Note: 1. The EUT function was correct during the test.

Input Power	230 Vac, 50 Hz	Tested by	Evan Liao
Environmental Conditions	23 °C, 58% RH	Test Date	2019/02/26
Test mode	2-3		

Frequency (MHz)	Polarity	Azimuth(°)	Applied Field Strength		Observation	Test Distance (m)	Performance Criterion
			(V/m)	Modulation			
80 - 1000	V&H	0	20	80% AM (1kHz)	Note 1	3	A
1400 - 2000	V&H	0	10	80% AM (1kHz)	Note 1	3	A
2000 - 2700	V&H	0	5	80% AM (1kHz)	Note 1	3	A
5100 - 6000	V&H	0	3	80% AM (1kHz)	Note 1	3	A

Note: 1. The EUT function was correct during the test.

10 Electrical Fast Transient/Burst Immunity Test (EFT)

10.1 Test Specification

Basic Standard:	EN/IEC 61000-4-4
Test Voltage:	Signal & communication, process measurement & control ports: $\pm 2\text{kV}$, Capacitive clamp Auxiliary a.c. power input ports (rated voltage $\leq 400\text{ Vrms}$): $\pm 2\text{kV}$
Impulse Repetition Frequency:	5kHz
Impulse Wave Shape:	5/50 (T_r/T_h) ns
Burst Duration:	15 ms
Burst Period:	300 ms
Test Duration:	1 min.

10.2 Test Instruments

Description & Manufacturer	Model No.	Serial No.	Cal. Date	Cal. Due
EMC Immunity Test System	NSG 3060/ CDN 3061/ VAR 3005-S16/ CDN 3425	1385/1355/857/1 763	Oct. 09, 2018	Oct. 08, 2019

- Notes: 1. The test was performed in Hwa Ya EMS Room 2.
2. The calibration interval of the above test instruments is 12 months and the calibrations are traceable to NML/ROC and NIST/USA.

10.3 Test Arrangement

- Both positive and negative polarity discharges were applied.
- The distance between any coupling devices and the EUT should be 0.5 m for table-top equipment testing, and 1.0 m for floor standing equipment.
- The duration time of each test sequential was 1 minute.
- The transient/burst waveform was in accordance with EN/IEC 61000-4-4, 5/50 ns.

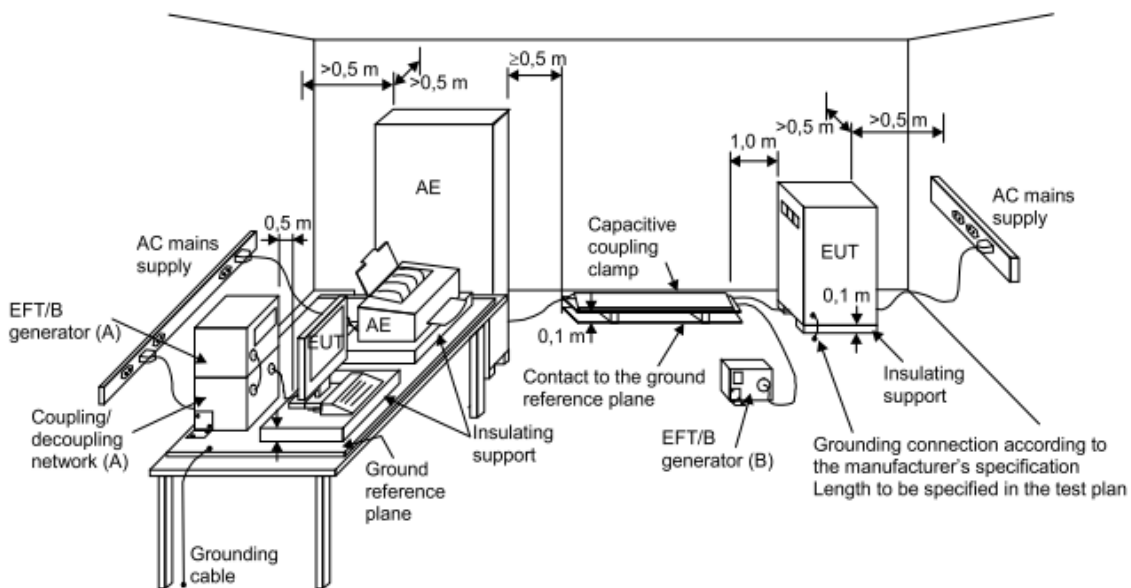

IEC 645/12

10.4 Test Results

Input Power	230 Vac, 50 Hz	Tested by	Howard Yang
Environmental Conditions	22 °C, 59% RH	Test Date	2019/02/26
Test mode	1-3		

Auxiliary a.c. power input ports (rated voltage \leq 400 Vrms)

Voltage (kV)	Test Point	Polarity (+/-)	Observation	Performance Criterion
2	L1	+/-	Note 1	A
2	L2	+/-	Note 1	A
2	L1-L2	+/-	Note 1	A
2	L1-L2-PE	+/-	Note 1	A

Note: 1. The EUT function was correct during the test.

Input Power	230 Vac, 50 Hz	Tested by	Howard Yang
Environmental Conditions	22 °C, 59% RH	Test Date	2019/02/26
Test mode	4, 6		

Signal & communication, process measurement & control ports

Voltage (kV)	Test Point	Polarity (+/-)	Observation	Performance Criterion
2	LAN 1	+/-	Note 1	A

Note: 1. The EUT function was correct during the test.

Input Power	230 Vac, 50 Hz	Tested by	Howard Yang
Environmental Conditions	22 °C, 59% RH	Test Date	2019/02/26
Test mode	5, 7		

Signal & communication, process measurement & control ports

Voltage (kV)	Test Point	Polarity (+/-)	Observation	Performance Criterion
2	POE LAN 6	+/-	Note 1	A

Note: 1. The EUT function was correct during the test.

11 Surge Immunity Test

11.1 Test Specification

Basic Standard:	EN/IEC 61000-4-5
Wave-Shape:	Auxiliary a.c. power input ports (rated voltage ≤ 400 Vrms): 1.2/50 μ s Open Circuit Voltage 8/20 μ s Short Circuit Current
Test Voltage:	Line to line: ± 0.5 kV, ± 1 kV, Line to ground: ± 0.5 kV, ± 1 kV, ± 2 kV output impedance of 42 Ω (40 Ω and 2 Ω generator) and a coupling capacitance of 0,5 μ F
AC Phase Angle (degree):	0°, 90°, 180°, 270°
Pulse Repetition Rate:	1 time / 60 sec.
Number of Tests:	5 positive and 5 negative at selected points

11.2 Test Instruments

Description & Manufacturer	Model No.	Serial No.	Cal. Date	Cal. Due
EMC Immunity Test System	NSG 3060	1385	Oct. 09, 2018	Oct. 08, 2019
EMC Immunity Test System	CDN 3061	1355	Oct. 09, 2018	Oct. 08, 2019
EMC Immunity Test System	VAR 3005-S16	857	Oct. 09, 2018	Oct. 08, 2019
Surge CDN	CDN HSS-2	36541	Oct. 09, 2018	Oct. 08, 2019
CDN for Unshielded symmetrical signal & Data Lines	CDN 118 / INA 172 / INA 175 / INA 180 / INA 181 / INA 182 / INA 183	33882 / 33245 / 35809 / 35806 / 35909 / 35912 / 35917 / 35927	Oct. 09, 2018	Oct. 08, 2019

- Notes: 1. The test was performed in Hwa Ya EMS Room 2.
2. The calibration interval of the above test instruments is 12 months and the calibrations are traceable to NML/ROC and NIST/USA.

11.3 Test Arrangement

The surge is to be applied to the EUT power supply terminals via the capacitive coupling network. Decoupling networks are required in order to avoid possible adverse effects on equipment not under test that may be powered by the same lines, and to provide sufficient decoupling impedance to the surge wave. The power cord between the EUT and the coupling/decoupling networks shall be 2 meters in length (or shorter).

For double-insulated products without PE or external earth connections, the test shall be done in a similar way as for grounded products but without adding any additional external grounded connections. If there are no other possible connections to earth, line-to-ground tests may be omitted.

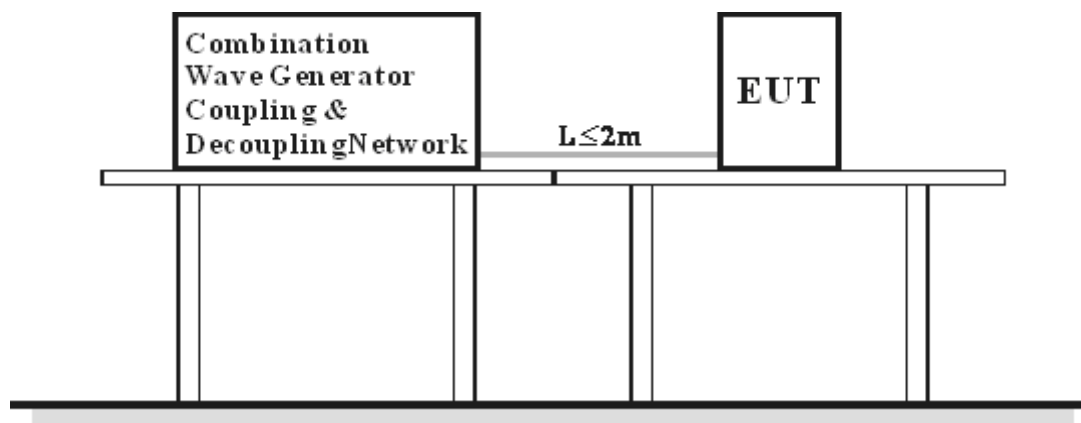

11.4 Test Results

Input Power	230 Vac, 50 Hz	Tested by	Howard Yang
Environmental Conditions	22 °C, 59% RH	Test Date	2019/02/25
Test mode	1-3		

Auxiliary a.c. power input ports (rated voltage \leq 400 Vrms)

Voltage (kV)	Test Point	Polarity (+/-)	Observation	Performance Criterion
0.5, 1	L1-L2	+/-	Note 1	A
0.5, 1, 2	L1-PE	+/-	Note 1	A
0.5, 1, 2	L2-PE	+/-	Note 1	A

Note: 1. The EUT function was correct during the test.

12 Immunity to Conducted Disturbances Induced by RF Fields (CS)

12.1 Test Specification

Basic Standard:	EN/IEC 61000-4-6
Frequency Range:	0.15 MHz - 80 MHz
Voltage Level:	Auxiliary a.c. power input ports (rated voltage \leq 400 Vrms), Signal & communication, process measurement & control ports: 10 V
Modulation:	1kHz Sine Wave, 80%, AM Modulation
Frequency Step:	1 % of preceding frequency value
Dwell Time	3 seconds

12.2 Test Instruments

Description & Manufacturer	Model No.	Serial No.	Cal. Date	Cal. Due
FCC SIGNAL LINE POWER LINE COUPLING DECOUPLING NETWORK	FCC-801-M2/M3-16A	112388	Mar. 04, 2019	Mar. 03, 2020
Coupling Decoupling Network TESEQ	CDN T8_Cat.6	39921	Mar. 04, 2019	Mar. 03, 2020
R&S Power Amplifier	BBA100	101012	NA	NA
R&S Signal generator	SMB100A	105802	Jan. 24, 2019	Jan. 23, 2020
R&S Software	EMC32 Version 8.52.0	NA	NA	NA
Power Sensor	NRP-Z91	101574	Jun. 26, 2018	Jun. 25, 2019
Power Sensor	NRP-Z91	101575	Jun. 08, 2018	Jun. 07, 2019
EAR SIMULATOR	4192	2764583	Oct. 11, 2018	Oct. 10, 2019
Conditioning Amplifier	Type 2690-0S2	2482371	Jun. 11, 2018	Jun. 10, 2019
Audio analyzer	UPV	101942	Dec. 18, 2018	Dec. 17, 2019

- Notes: 1. The test was performed in Hwa Ya CS Room 2.
 2. The calibration interval of the above test instruments is 12 months and the calibrations are traceable to NML/ROC and NIST/USA.

12.3 Test Arrangement

- The EUT shall be tested within its intended operating and climatic conditions.
- An artificial hand was placed on the hand-held accessory and connected to the ground reference plane.
- One of the CDNs not used for injection was terminated with 50 ohm, providing only one return path. All other CDNs were coupled as decoupling networks.
- The frequency range is swept from 150 kHz to 80 MHz, using the signal level established during the setting process and with a disturbance signal of 80 % amplitude. The signal is modulated with a 1 kHz sine wave, pausing to adjust the RF signal level or the switch coupling devices as necessary. Where the frequency is swept incrementally, the step size shall not exceed 1 % of the preceding frequency value.
- Attempts should be made to fully exercise the EUT during testing, and to fully interrogate all exercise modes selected for susceptibility.

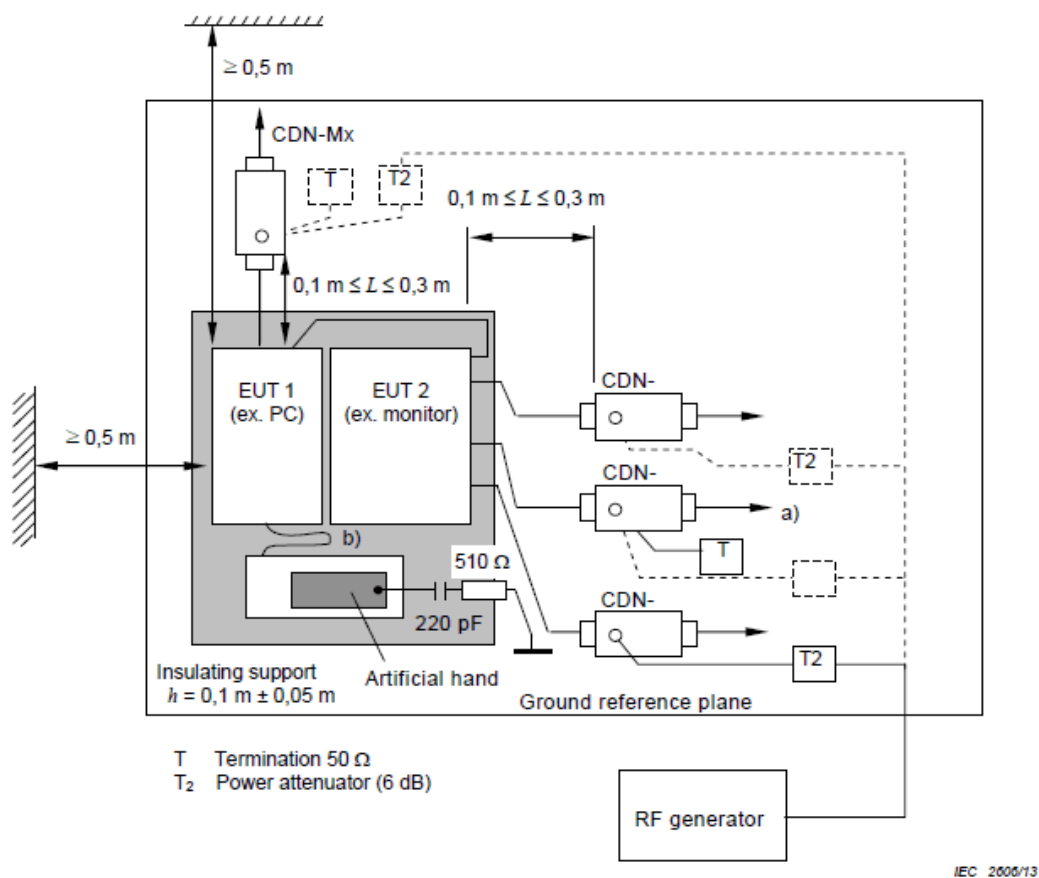

- Only one of the CDNs not used for injection shall be terminated with 50 Ω, providing only one return path. All other CDNs shall be configured as decoupling networks.
- Interconnecting cables (≤ 1 m) belonging to the EUT shall remain on the insulating support.

12.4 Test Results

Input Power	230 Vac, 50 Hz	Tested by	Evan Liao
Environmental Conditions	23 °C, 58% RH	Test Date	2019/03/06
Test mode	1-3		

Frequency (MHz)	Level (V rms)	Tested Line	Injection Method	Return Path	Observation	Remark	Performance Criterion
0.15 – 80	10	AC	CDN-M3	CDN-M1	Note 1	-	A

Note: 1. The EUT function was correct during the test.

Input Power	230 Vac, 50 Hz	Tested by	Evan Liao
Environmental Conditions	23 °C, 58% RH	Test Date	2019/03/06
Test mode	4, 6		

Frequency (MHz)	Level (V rms)	Tested Line	Injection Method	Return Path	Observation	Remark	Performance Criterion
0.15 – 80	10	LAN 1	CDN-T8	CDN-M1	Note 1	-	A

Note: 1. The EUT function was correct during the test.

Input Power	230 Vac, 50 Hz	Tested by	Evan Liao
Environmental Conditions	23 °C, 58% RH	Test Date	2019/03/06
Test mode	5, 7		

Frequency (MHz)	Level (V rms)	Tested Line	Injection Method	Return Path	Observation	Remark	Performance Criterion
0.15 – 80	10	LAN POE 6	CDN-T8	CDN-M1	Note 1	-	A

Note: 1. The EUT function was correct during the test.

13 Pictures of Test Arrangements

13.1 Conducted Disturbance at Auxiliary a.c. or d.c. power ports



13.2 Radiated Disturbance up to 1 GHz

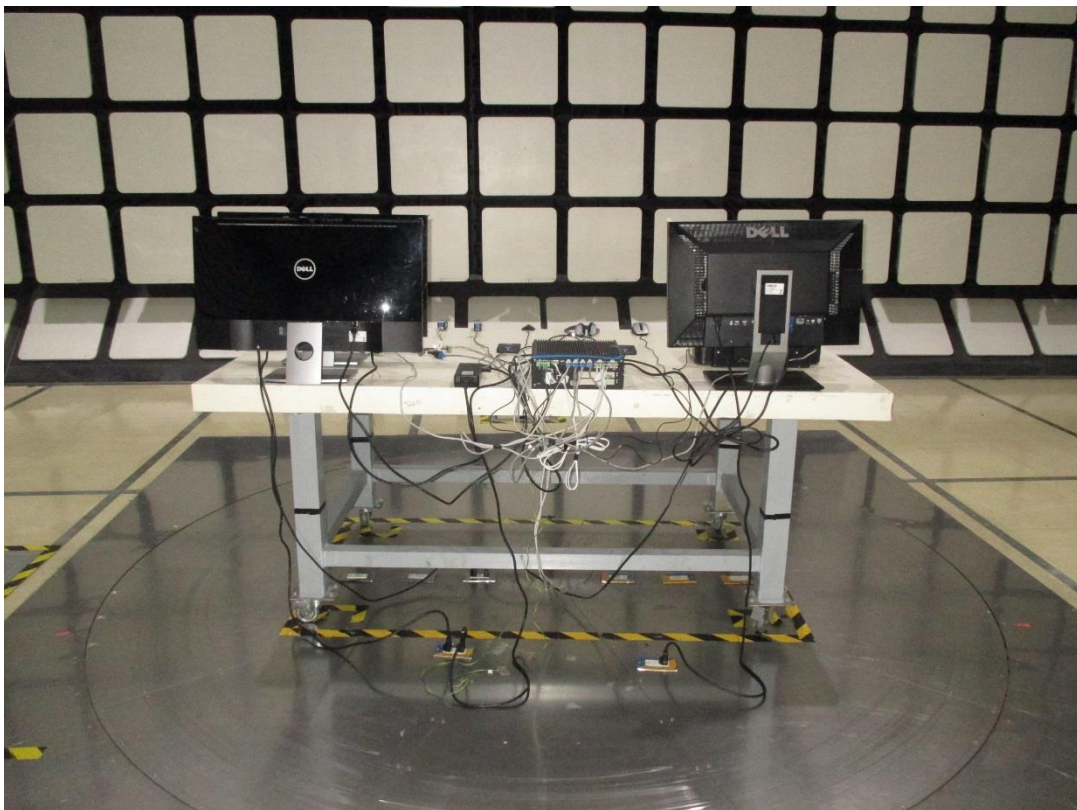

13.3 Radiated Disturbance above 1 GHz

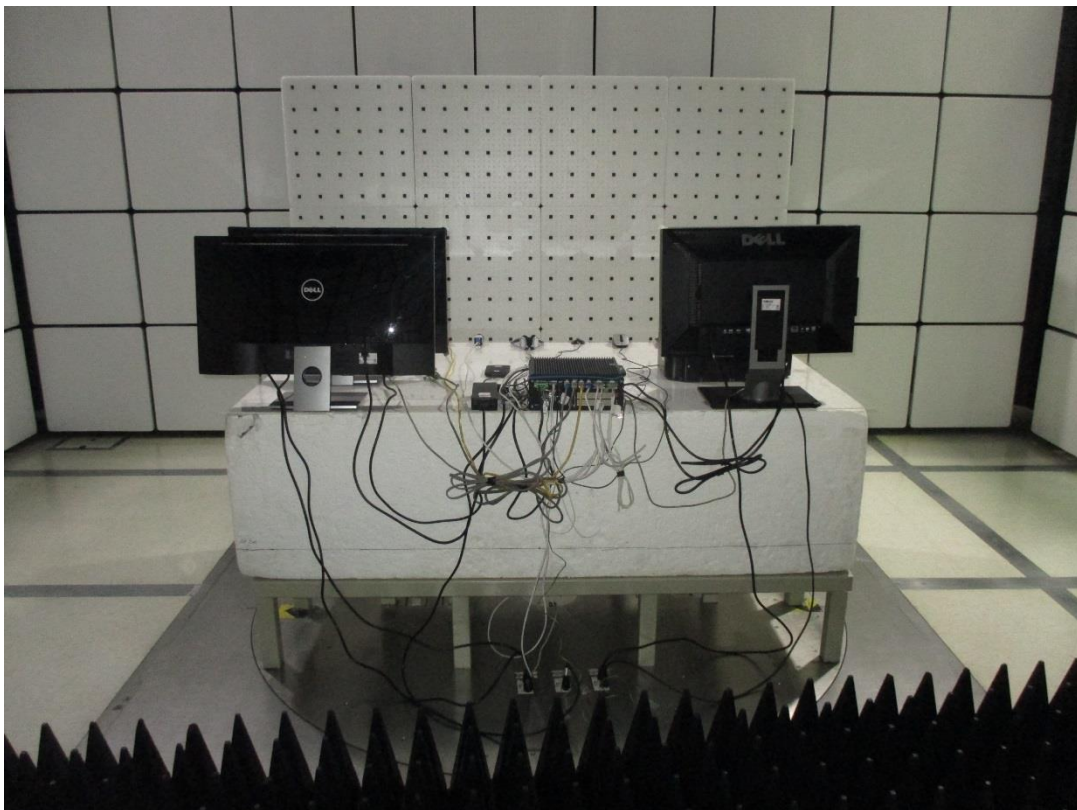
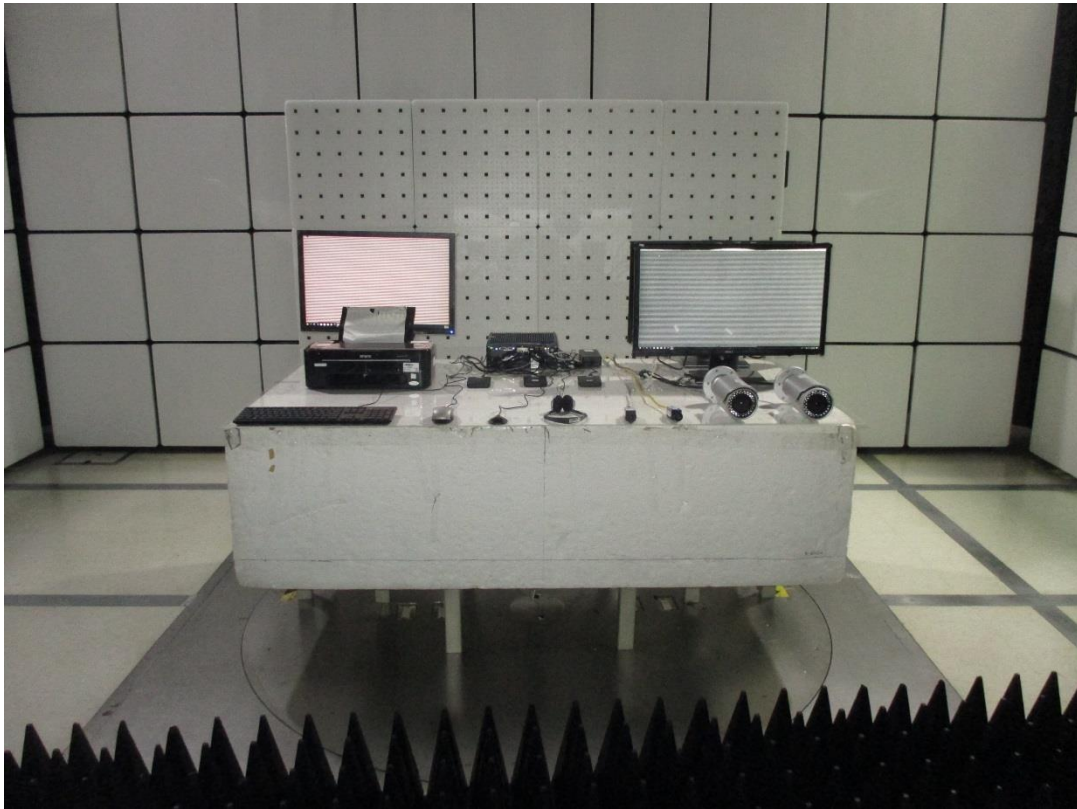

13.4 Electrostatic Discharge Immunity Test (ESD)

(Mode 1)



(Mode 2)



(Mode 3)



13.5 Radio-frequency Electromagnetic Field Immunity Test (RS)

(Mode 1_0 degree)



(Mode 1_90 degree)

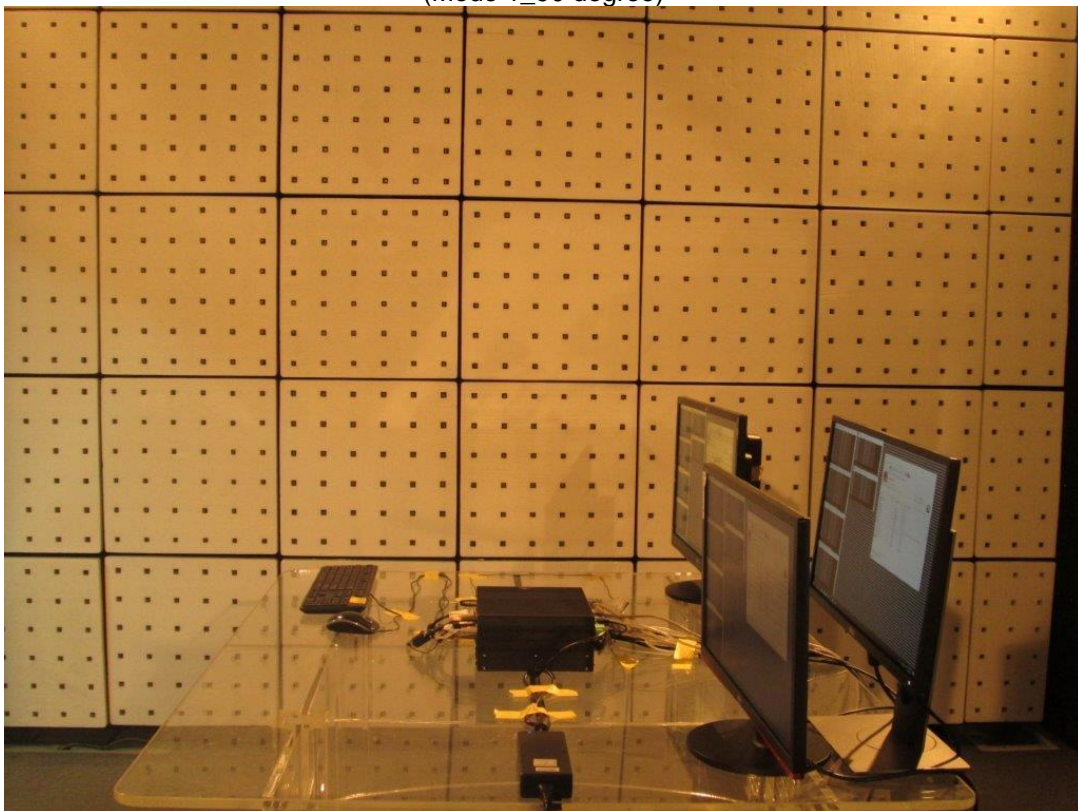

(Mode 1_180 degree)

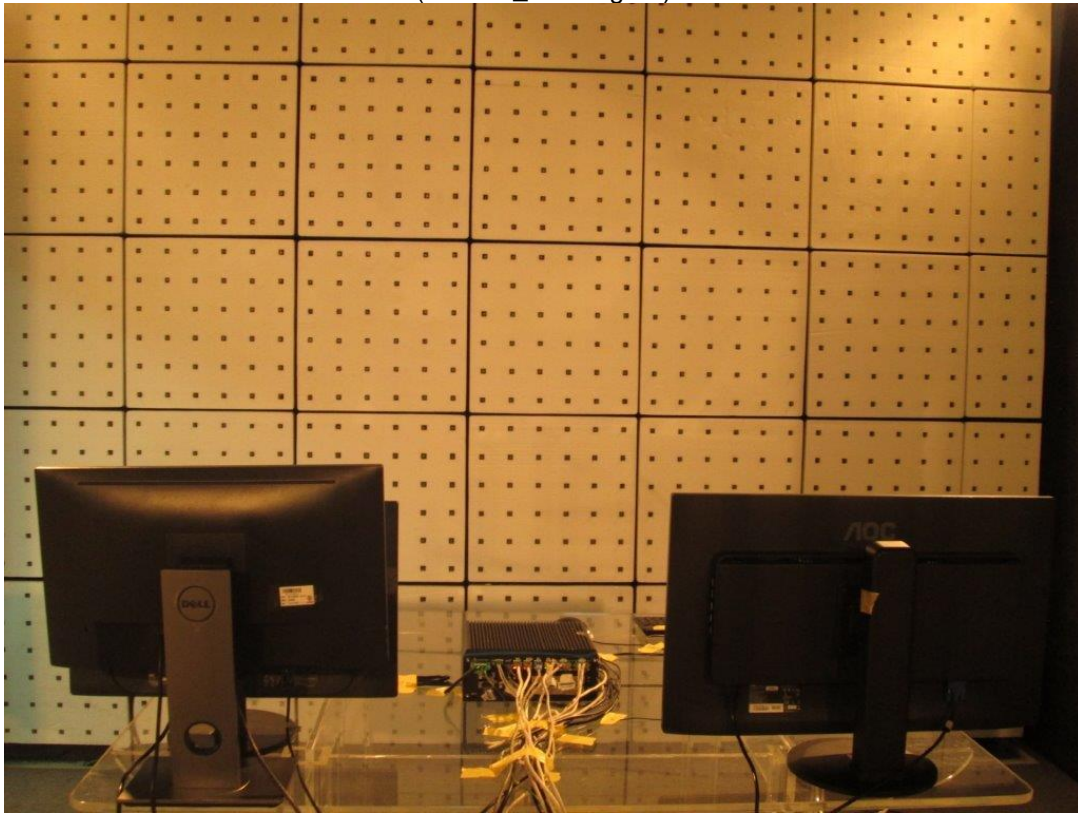

(Mode 1_270 degree)

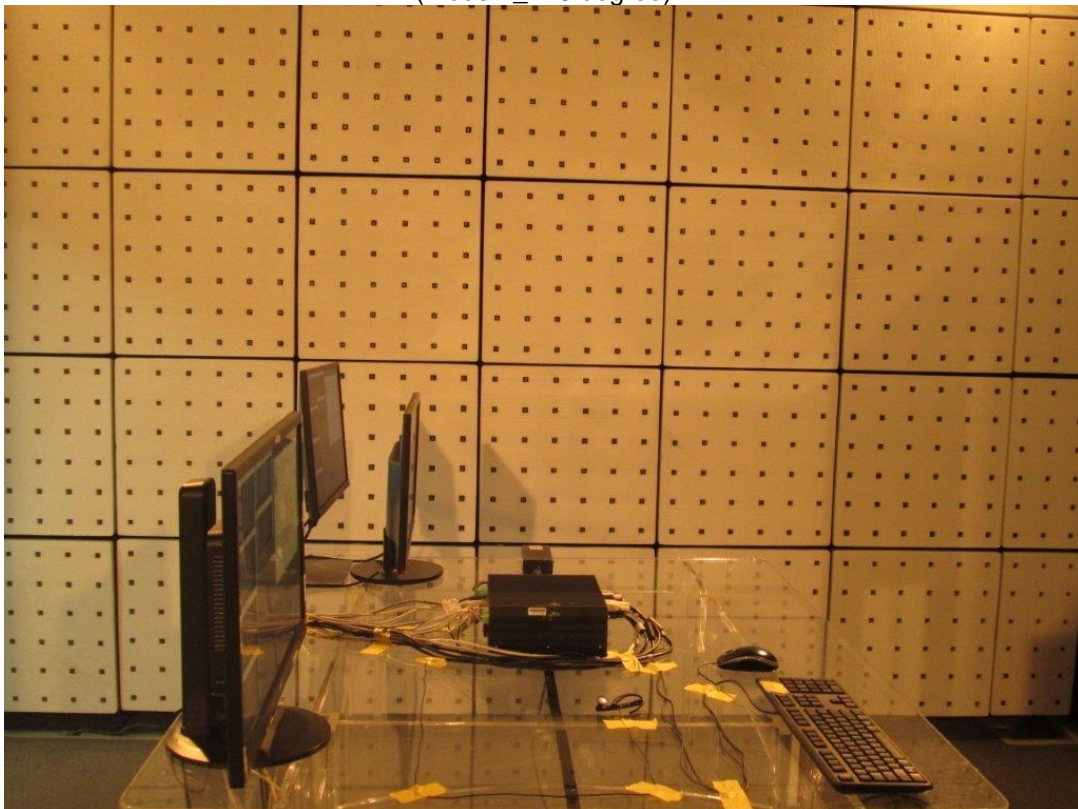

(Mode 2)



(Mode 3)

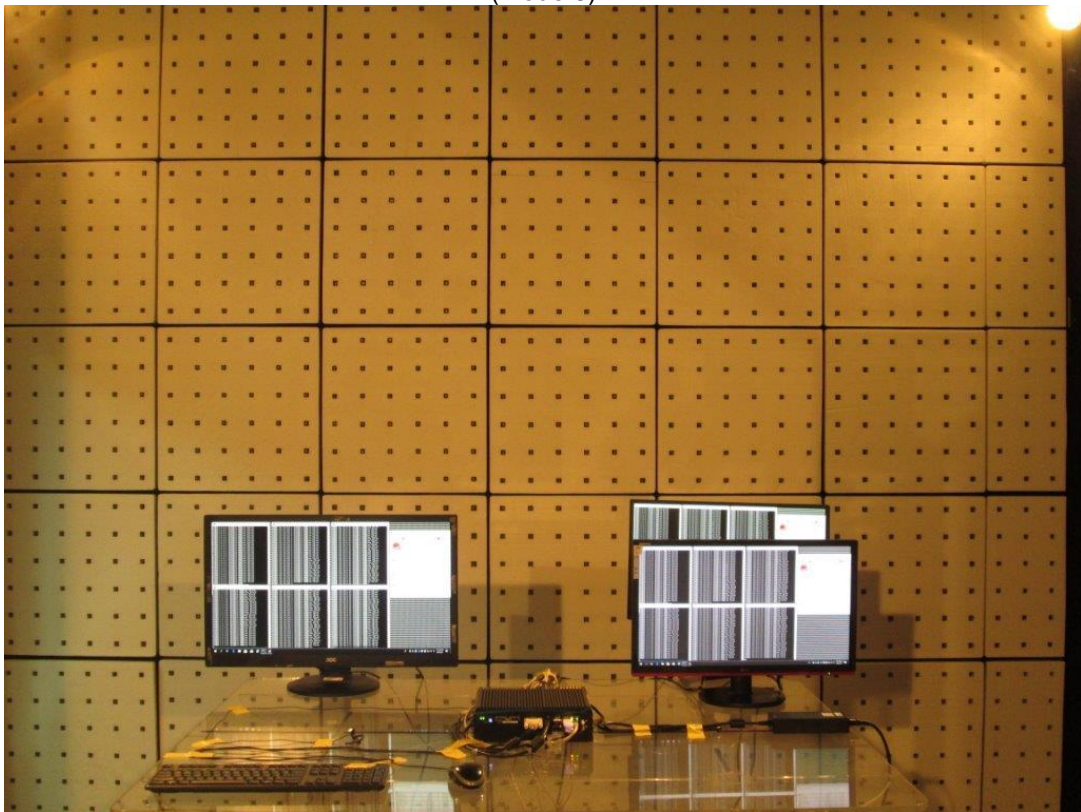

13.6 Fast Transients (EFT)

(Mode 1)



(Mode 2)



(Mode 3)



(Mode 4)



(Mode 5)



(Mode 6)



(Mode 7)



13.7 Surge

(Mode 1)



(Mode 2)



(Mode 3)

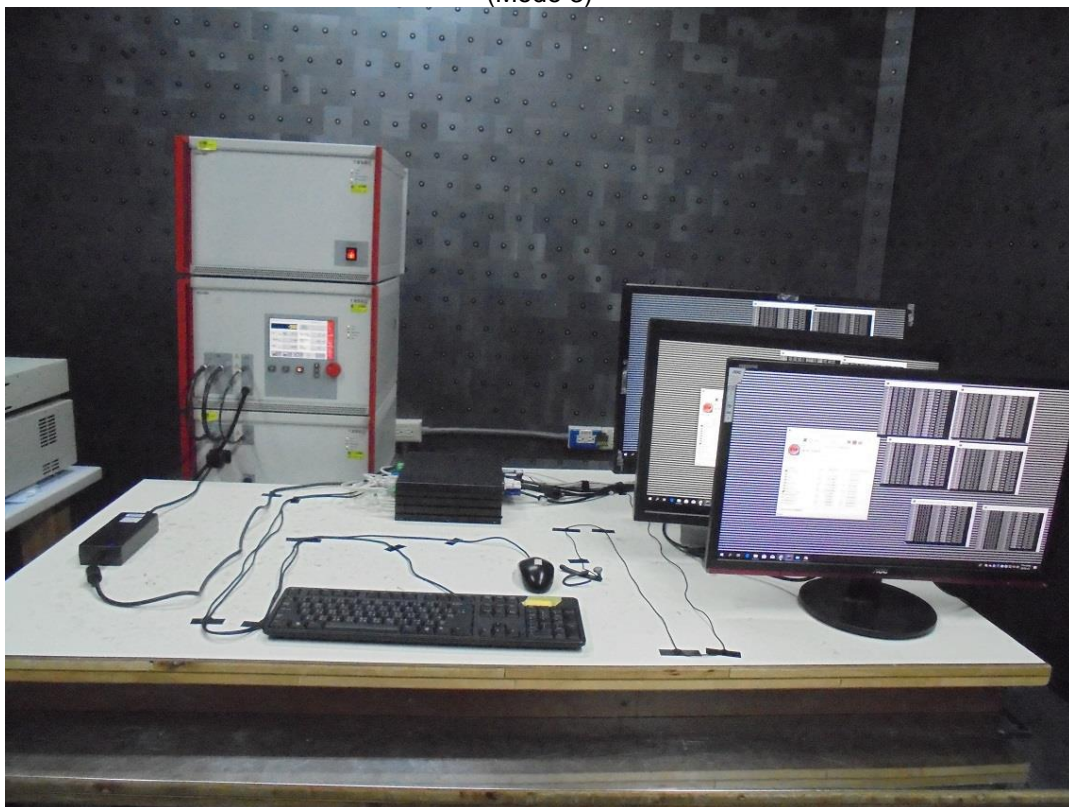

13.8 Radio-frequency common mode (CS)

(Mode 1)

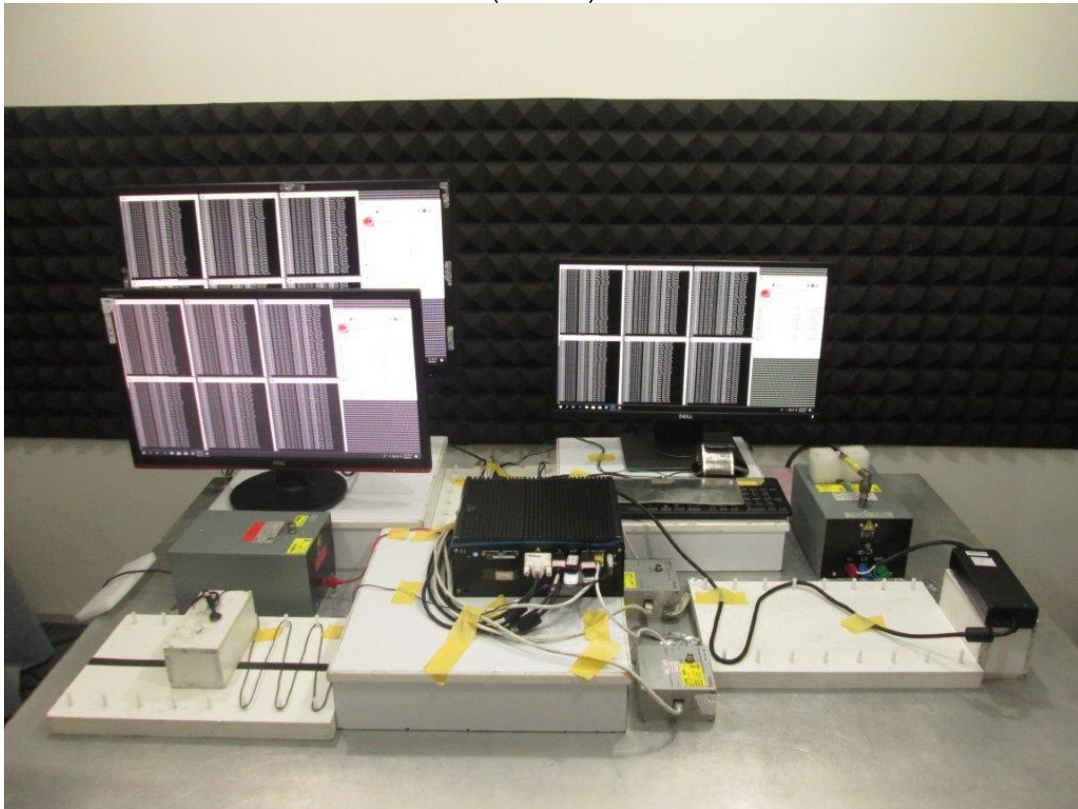

(Mode 2)

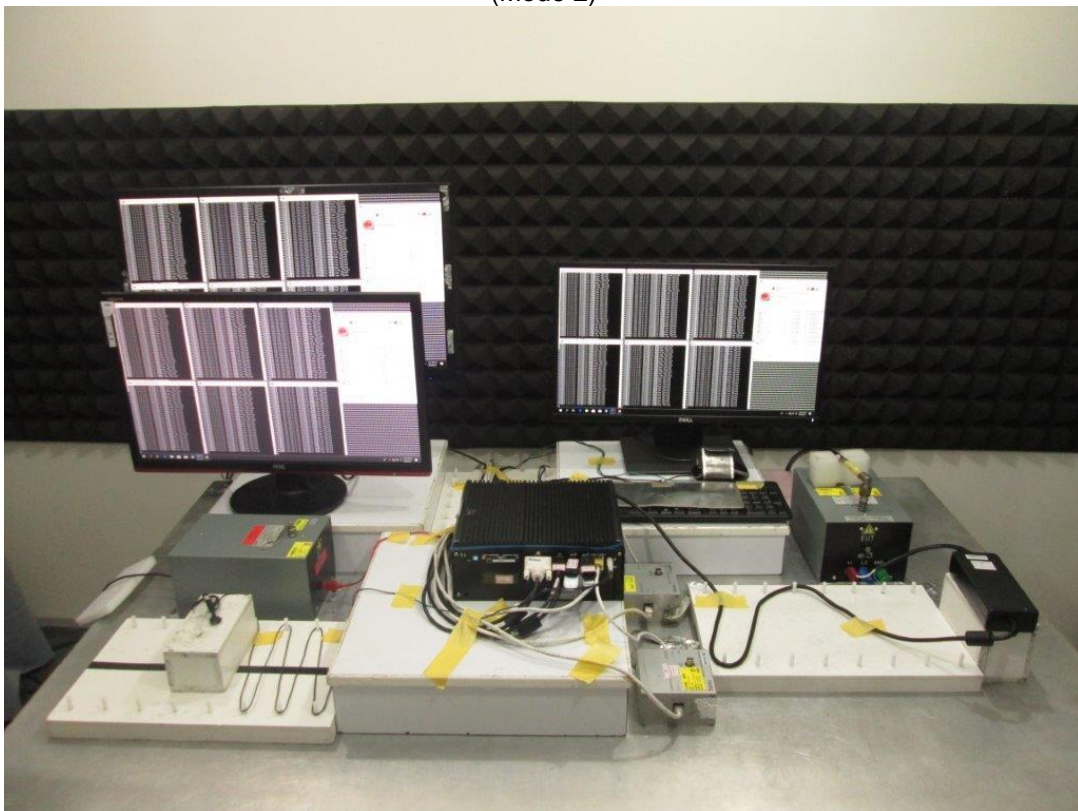

(Mode 3)

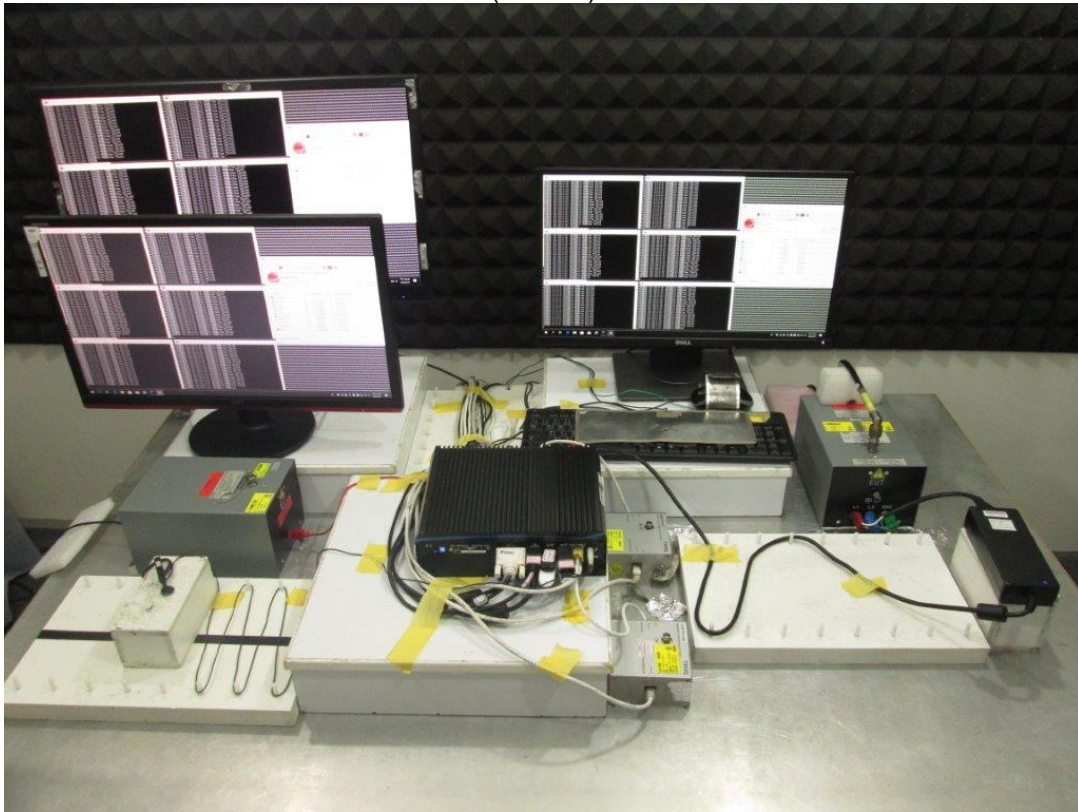

(Mode 4)

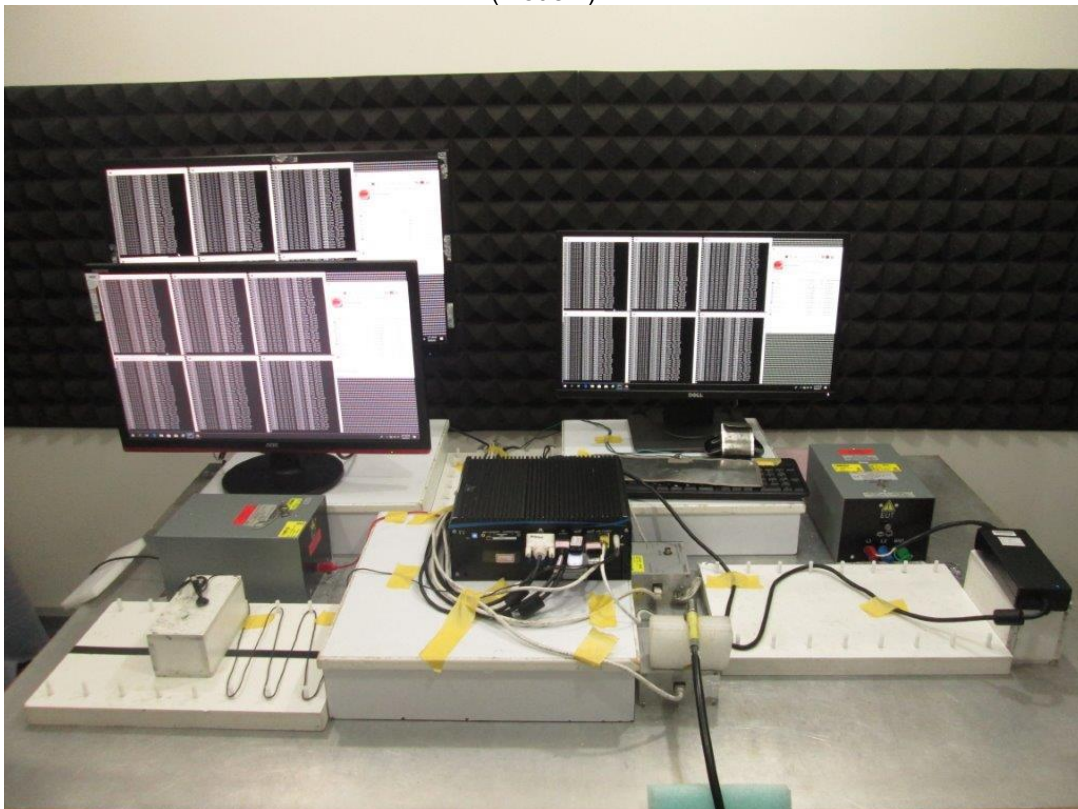

(Mode 5)

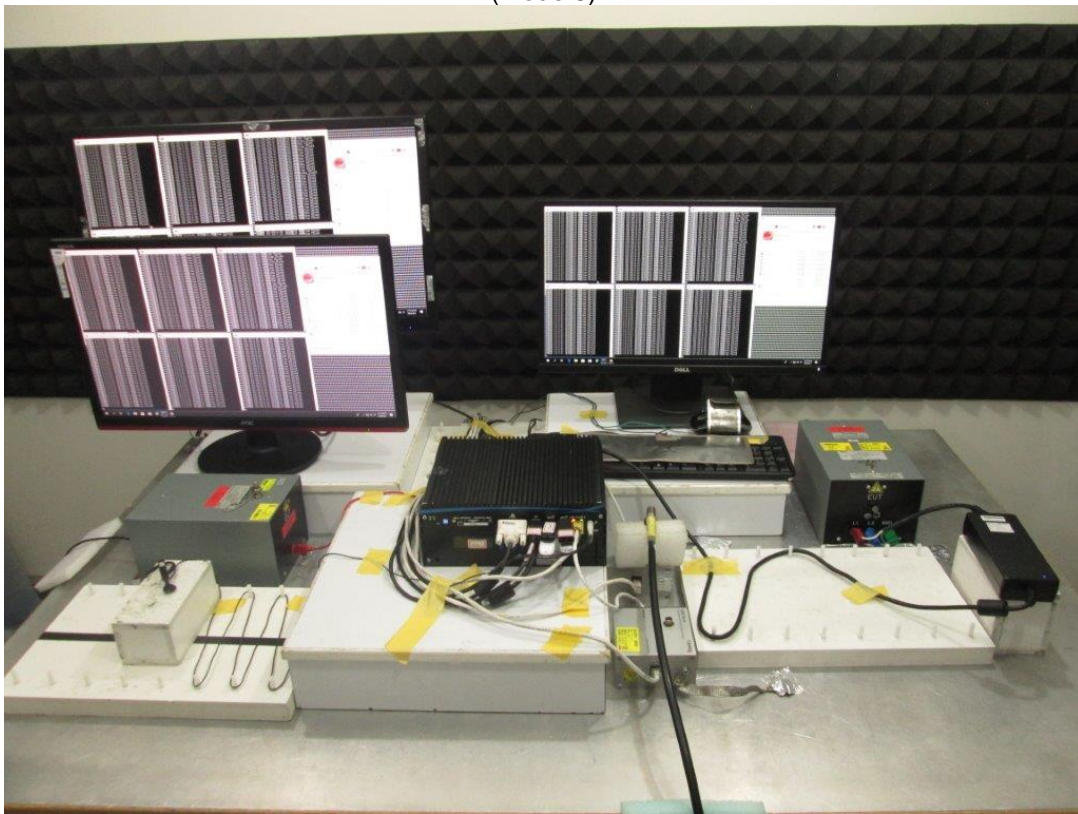

(Mode 6)

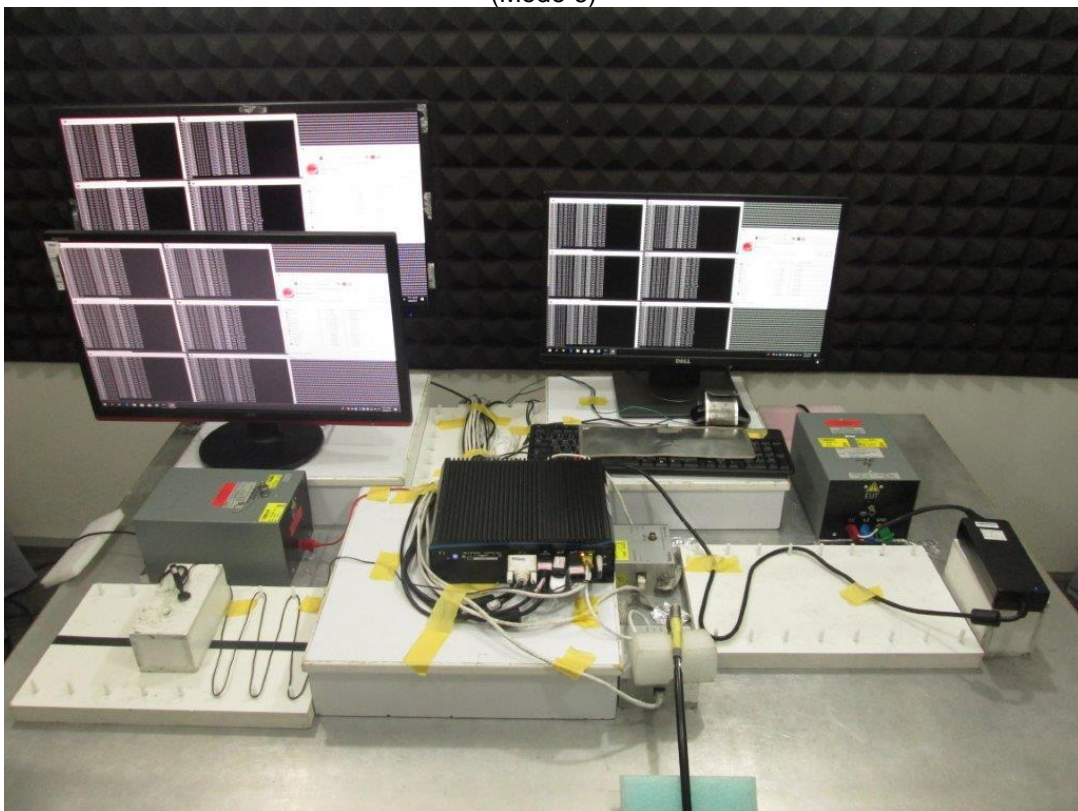

(Mode 7)

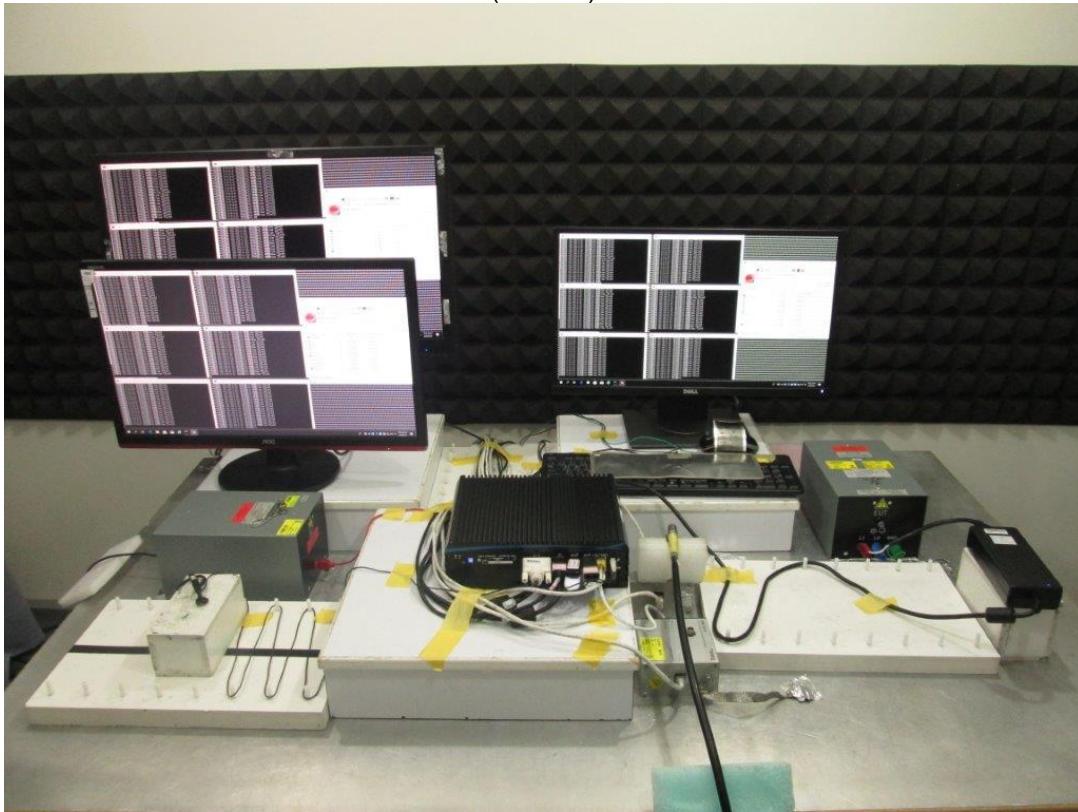

Appendix – Information of the Testing Laboratories

We, Bureau Veritas Consumer Products Services (H.K.) Ltd., Taoyuan Branch, were founded in 1988 to provide our best service in EMC, Radio, Telecom and Safety consultation. Our laboratories are accredited and approved according to ISO/IEC 17025.

If you have any comments, please feel free to contact us at the following:

Linko EMC/RF Lab

Tel: 886-2-26052180

Fax: 886-2-26051924

Hsin Chu EMC/RF/Telecom Lab

Tel: 886-3-6668565

Fax: 886-3-6668323

Hwa Ya EMC/RF/Safety Lab

Tel: 886-3-3183232

Fax: 886-3-3270892

Email: service.adt@tw.bureauveritas.com

Web Site: www.bureauveritas-adt.com

The address and road map of all our labs can be found in our web site also.

--- END ---